

# The Wireless Constructor

6<sup>D</sup>  
MONTHLY



EDITED BY  
**PERCY W. HARRIS, M.I.R.E.**

Vol. II

OCTOBER, 1926

No. 12

## The NIGHT HAWK

By  
**PERCY W. HARRIS, M.I.R.E.**

Special  
Free gift  
with this  
Issue



# SEE FOR YOURSELF

VISIT STANDS  
136 and 138



## Valves with the wonderful P.M. Filament

The best way to see for yourself the wonderful P.M. Filament is to visit our stands at the 1926 Olympia Wireless Exhibition—Sept. 4th to 18th.

There you will be able to inspect a giant model of a P.M. Valve showing all the master features of the P.M. Filament and the complete construction that is in keeping with its superiority.

Actual demonstrations of the strength of the P.M. Filament will prove to you its power to resist the very roughest handling, and the increased value offered by this P.M. Filament will convince you that P.M. Valves are the finest that have ever been produced.

Only P.M. Valves embody the P.M. Filament that can offer you greater length of valve life, purer reception, majestic volume and an economy that means seven times the life from each accumulator charge.

Find out all about the P.M. Filament before you select your valves for the coming winter.

*Ask your Dealer for the Valves  
with the Wonderful P.M. Filament.*

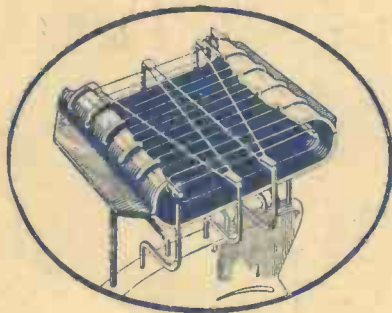

### NEW REDUCED PRICES

For 4-volt accumulator or 3 dry cells  
THE P.M.3 (General Purpose)

0.1 amp. 14/-

THE P.M.4 (Power) 0.1 amp. 18/6

For 6-volt accumulator or 4 dry cells  
THE P.M.5 (General Purpose)

0.1 amp. 18/6

THE P.M.6 (Power) 0.1 amp. 18/6

For 2-volt accumulator

THE P.M.1 H.F. 0.1 amp. 14/-

THE P.M.1 L.F. 0.1 amp. 14/-

THE P.M.2 (Power) 0.15 amp. 18/6

*These prices do not apply in Irish Free State*

# Mullard

## THE · MASTER · VALVE

# The WIRELESS CONSTRUCTOR

— Edited by Percy W. Harris —

Vol. II. No. 12      CONTENTS      OCTOBER

<p>The "Night Hawk" .. 1047 By PERCY W. HARRIS, M.I.R.E., Editor. Things That Every Operator Should Know .. 1053 By G. P. KENDALL, B.Sc. The "Distaflex Two" .. 1056 Described by J. H. REYNER, B.Sc. (Hons.), A.C.G.I., D.I.C., A.M.I.E.E. Radio Press Lecture Tour .. 1063 The Truth (?) About Condensers .. 1064 By ANNE N. NIAS. Talks to Beginners—VII .. 1069 By PERCY W. HARRIS, M.I.R.E., Editor. The "Recruit's" Single-Valve Receiver .. 1073 By GEORGE T. KELSEY.</p>	<p>Notes and Jottings .. 1078 The National Radio Exhibition, 1926 1081 Why Are Screened Coils Used? 1085 By J. H. REYNER, B.Sc. (Hons.), A.C.G.I., D.I.C., A.M.I.E.E. Tracing Trouble in a Single-Valve Set 1088 The "Casket" Crystal Set .. 1094 By H. BRAMFORD. Which Set Shall I Build? .. 1097 By C. E. M. A New Era in Wireless Reception .. 1102 Workshop Hints .. 1107 Have You Tried the Superhet? .. 1110 By JOHN UNDERDOWN. Apparatus Tested .. 1121</p>
--	--



## TWO STAR SETS OF OUTSTANDING MERIT DESCRIBED IN THIS ISSUE.

THE NIGHT HAWK.	£ s. d.
1 Special Cabinet (Mahogany) ..	1 16 0
1 Ebonite Panel, 16x8x1/2, ready drilled ..	9 0
3 Eureka S.L.F. Condensers .0005 ..	2 6 6
3 Sets Lissen Fieldless Coils ..	1 10 0
5 Lotus Valve Holders ..	11 3
6 T.C.C. Condensers .001 mfd. ..	14 0
1 T.C.C. Condenser .0003 with clips ..	2 4
1 T.C.C. Condenser .002 mfd. ..	2 0
2 Mansbridge Condensers 2 mfd. ..	9 4
1 Panel Mounting Neutralising Condenser ..	5 0
1 Lissen, 7 ohm Baseboard Rheostat ..	2 6
1 Lissen, 35 ohm Baseboard Rheostat ..	2 6
1 Varley H.F. Choke ..	9 6
4 Dumetohm bases ..	4 0
3 Dubilier Resistances .25 meg. ..	7 6
1 Dubilier Resistance .5 meg. ..	2 6
1 Dubilier Resistance 2 meg. ..	2 6
1 Dubilier Condenser .01 ..	4 0
1 Dubilier Condenser .0003 with clips ..	2 6
1 C.A.V. All-Purpose L.F. Transformer ..	15 0
1 Success L.F. Choke ..	18 6
2 M.H. Neutralising Condensers ..	9 6
2 Magnum Panel Brackets ..	1 6
1 Igranite Push-Pull Switch ..	2 6
Connecting Wire and Sundries ..	2 11
(Cabinet can be supplied in Oak if desired. Price £1 12s.)	£12 10 6

MAGNUM RESISTORS are suitable for all Modern Sets, including:—The Night Hawk; The Distaflex Two; The Eistree Six; The Eistree Solio-syne, etc., etc.



Resistor on base ..	2 6
Resistor only ..	1 9
Shorting Plug ..	1 0
Size:	
Overall size of base, 2 1/2 in. by 1/2 in.	
Overall height, 1 1/2 in.	

### MAGNUM SCREENED COILS.



No. 1058.

**NEW STANDARD COILS AND PRICES.**

<b>MAGNUM</b> Screening Box, complete with 6-Pin base (Standard spacing and cross formation) ..			15s.
<b>Split Primaries.</b>			
Aerial Coll ..	250/550	s. d.	6 0
H.F. Transformer ..	250/550		10 0
Aerial Coll ..	1000/2000		6 0
H.F. Transformer ..	1000/2000		10 0
<b>Split Secondaries.</b>			
H.F. Transformer ..	250/550		10 0
H.F. Transformer ..	1000/2000		14 0
Reinartz Coil ..	250/550		10 0
Reinartz Coil ..	1000/2000		14 0

Size of Screening Box:  
Overall height, 4 1/2 in.; Dia. of base, 4 1/2 in.  
Set of 3 Screened Coils as used in The Distaflex Two, described in this issue .. £3 15s.

**BURNE-JONES & Co., Ltd.,**  
Manufacturing Radio Engineers,  
**Magnum House,**  
**296, BOROUGH HIGH ST.,**  
**LONDON, S.E.1.**

Telephone: Hop 6257.  
Telegram: "Burjomag, Sedist, London."  
Cables: "Burjomag, London."

### THE DISTAFLEX TWO.

	£ s. d.
1 Special Cabinet (Mahogany) ..	2 6 0
1 Ebonite Panel, 21x7x1/2, ready drilled ..	14 0
3 Collinson Dual Condensers .0005 ..	3 18 0
3 Magnum Screened Coils, complete ..	3 15 0
1 Ferranti L.F. Transformer ..	1 5 0
1 R.I. Multi Ratio Transformer ..	1 7 6
2 Benjamin Valve Holders ..	5 6
2 Dubilier Fixed Condensers .0001 ..	5 0
1 Dubilier Fixed Condenser .002 ..	3 0
1 Dubilier Leak, 2 meg. ..	2 6
1 T.C.C. Fixed Condenser .0003 ..	1 10
1 R.I. P.M. Detector ..	7 6
1 Baseboard Neutralising Condenser ..	5 0
1 Panel Neutralising Condenser ..	5 8
2 Igranite Double Circuit Jacks ..	5 0
1 C.A.V. Filament Rheostat ..	5 0
Connecting Wire and Sundries ..	4 2
	<b>£15 15 0</b>

(Cabinet can be supplied in Oak if desired, Price £2 4s.)

### MAGNUM NEUTRALISING CONDENSER. No. 1051 A.

A new design, suitable for both Baseboard and Panel Mounting.  
Recommended for all Neutrodyne Receivers.  
Price 5s.  
Size, 2-in. dia. x 4 1/2 in. overall.

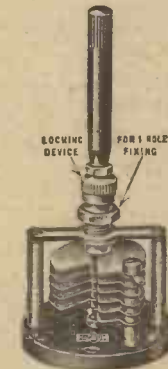

**OLYMPIA EXHIBITION.**  
At Stand No. 111 will be seen some of the finest examples of British Radio design and craftsmanship.

Send Stamp for latest tests dealing with Radio Press Constructional Sets, Magnum Receivers, and Components.

Note.—Where a complete set of Components, together with a drilled panel, is purchased, Royalties at the rate of 12s. 6d. per valve holder, are payable.

In replying to advertisers, please mention THE WIRELESS CONSTRUCTOR.

Another  
**FREE  
 GIFT**  
 for every reader  
 of this  
 magazine

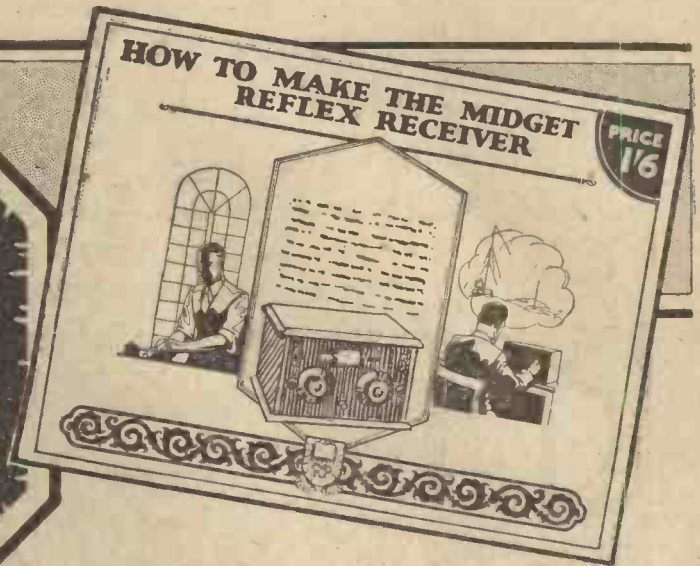

**R**EADERS of "THE WIRELESS CONSTRUCTOR" will receive with the November issue another wonderful FREE GIFT, "How to build the Midget Reflex Receiver."

This will take the form of a constructional envelope, the contents of which will be similar to that of the famous Radio Press Envelopes, known to every home constructor.

Since this issue of "THE WIRELESS CONSTRUCTOR" will also be a Special Birthday Number you will be best advised to place an order with your newsagent today, otherwise you may have great difficulty in securing your copy.

November Issue on Sale October 15.

*The* **Wireless  
 Constructor**

SIXPENCE PER MONTH.



The Editor: PERCY W. HARRIS, M.I.R.E.

Contents of the next issue include:

- The "INVALID'S THREE"  
by the Elstree Laboratories.
- A STABLE TWO-VALVE SET  
by G. P. Kendall, B.Sc.
- A further article on the "DISTAFLEX TWO,"  
the Radio Press Star Set described in the  
October issue.
- Notes on the "NIGHT HAWK,"  
by Percy W. Harris, M.I.R.E.
- Also interesting articles by J. H. Reyner B.Sc.  
(Hons.), D.I.C., A.C.G.L, A.M.I.E.E., and  
other well-known writers.

*From the nearest newsagent*



Published by Radio Press, Ltd., Bush House, Strand, W.C.2. 'Phone : City 9911.

# THE MUSIC OF EUROPE IN YOUR HOME

## Long Distance Reception for Everyone

### Full Description of the "Night Hawk"

#### A Radio Press Star Set

By PERCY W. HARRIS, M.I.R.E., Editor.

LAST year, after returning from a tour of the leading American radio centres, I wrote: "Just as Great Britain was the first to realise and put into practical operation the advantages of unified control of broadcasting, so America has been the first country to realise that the technical future of broadcasting is inseparably tied up with the development of tuned high-frequency amplification." The technique of audio frequency amplification and valve detection has been well understood in this country for a long time, and certainly we have nothing to learn from other countries in this respect. But when you come to consider that sensitivity and selectivity—two immensely important factors in the development of receiver design—are inseparably bound up with the development of tuned radio-frequency amplification, you will readily understand why Radio Press, Limited, in their Research Laboratories at Elstree, and the individual writers in their own research work, have devoted so much time in the last twelve months to the subject.

#### Simplicity

The "Night Hawk," which, I venture to hope, will in the future be a

knobs and switches, once the delight of the real enthusiast, has given way to the simple panel with three tuning dials, an "on and off" switch and a small condenser knob for that final touch of reaction amplification which is so valuable. Indeed, there are fewer knobs than on many of the most popular American receivers.



The appearance of the "Night Hawk" is plain almost to the point of severity.

willing searcher of the ether for WIRELESS CONSTRUCTOR readers, is my own interpretation of the technique which has been so steadily developing in the improvement of radio receivers. Its appearance, as you will notice, is plain almost to the point of severity. The old-fashioned array of multitudinous

#### Compact Layout

If you lift the lid of the cabinet you will find inside five valves symmetrically disposed, not in one straight line, but in such a manner that the radio-frequency and detector valves come near to their tuning controls, while the audio-frequency valves, which are not concerned in the tuning, are disposed at the back.

By adopting this arrangement it is possible to obtain a good layout for the essential parts, while avoiding lengthy and expensive panels. Actually the panel used is of the standard 16 in. x 8 in. size, which is well known in conjunction with other receivers, such as the "All Concert De Luxe."

# The "Night Hawk"

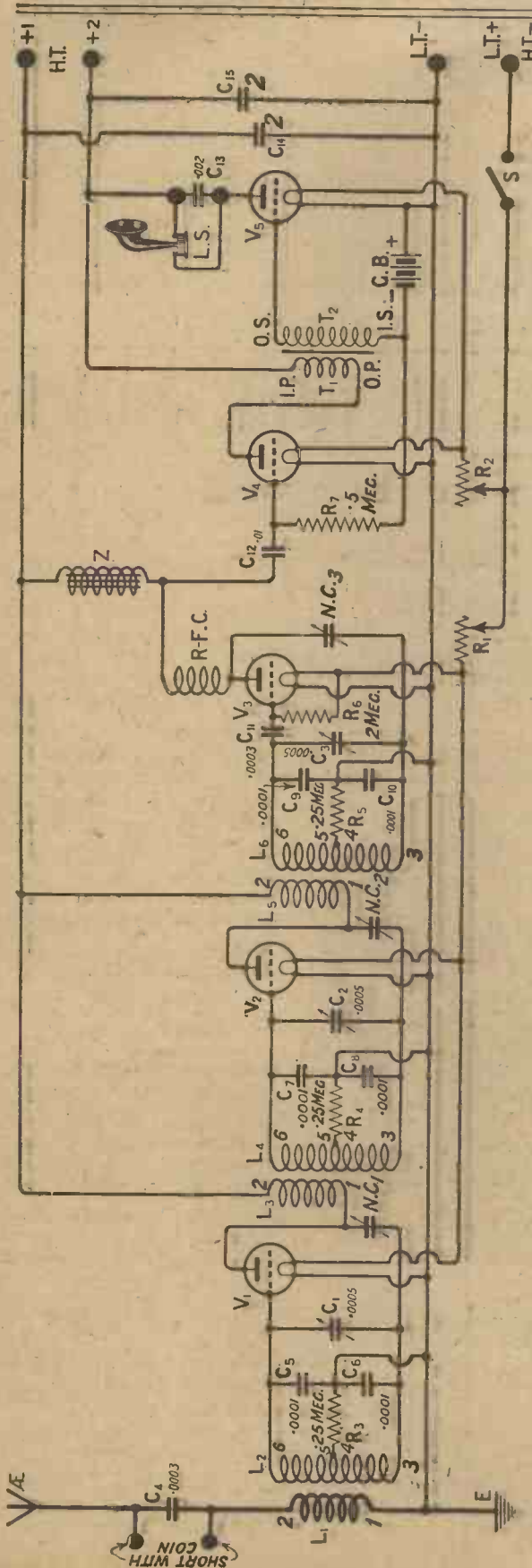

Fig. 1.—The various terminal points are shown conventionally in this diagram, though in the receiver no separate terminals are provided.

## Points in the Design

Before proceeding to a description of the constructional details, let me tell you a little about the design itself and its distinctive features. I have long felt that for good all-round reception of near and distant stations a five-

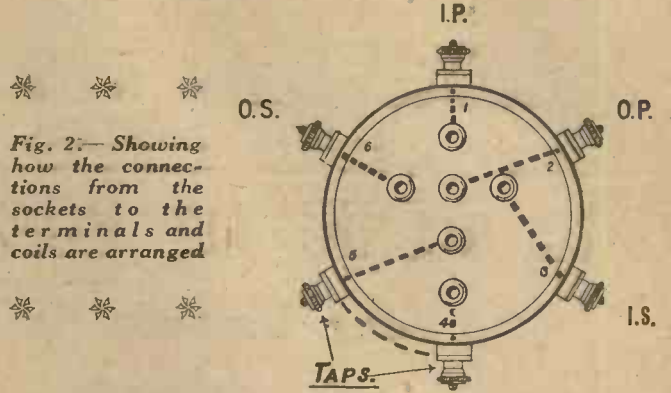

Fig. 2.—Showing how the connections from the sockets to the terminals and coils are arranged

valve receiver is excellent in many ways. Nowadays everybody wants loud-speaker reproduction, particularly since loud-speakers have reached such a high state of perfection. This means that for adequate volume on average aerials two stages of note-magnification must follow the detector. At the same time to get long-distance reception without distortion I feel that two stages of efficient radio-frequency amplification are required to give you "something in hand." At the same time the high selectivity demanded by modern conditions is difficult to obtain without the use of two stages of radio-frequency magnification.

## OFFICIAL TEST REPORT

The following stations were received on the loud-speaker at Elstree, using an aerial 60 ft. long and 20 ft. high; head telephones were not used at all during this test.

Station.	Dial Reading.	Station.	Dial Reading.
Elberfeld ... ..	22	Bournemouth ... ..	108
Malmo ... ..	34	Hamburg ... ..	111
Bremen ... ..	39	Dublin ... ..	116
Hanover ... ..	55	Newcastle ... ..	118
Stoke-on-Trent ... ..	59	Muenster ... ..	120
Bradford ... ..	65	Bilbao ... ..	121
Leeds ... ..	70	Breslau ... ..	122
Barcelona ... ..	74	Glasgow ... ..	125
Nottingham ... ..	76	Rome ... ..	127
Petit Parisien ... ..	78	Radio Toulouse ... ..	128
Hull ... ..	80	Berne ... ..	130
San Sebastian ... ..	86	Belfast ... ..	132
Cardiff ... ..	90	Leipzig ... ..	135
London ... ..	98	Frankfurt ... ..	140
Manchester ... ..	104	Birmingham ... ..	143
Oslo ... ..	106		

## Eliminating Direct Pick-up

Another problem we have to consider in the design of a modern set is the necessity of avoiding what is known as "pick-up" by the coils themselves, this enabling any interfering signals to get straight to the detector

# A Radio Press Star Set which You should Build

without passing through the tuned circuits designed for them. No matter how sharply a receiver may tune the signals picked up on its asso-

small aerial, which can quite easily happen. Indeed, one frequently hears the remark about a certain receiver, that it gives splendid signals from

of course, that the instrument itself is picking up the energy, a most undesirable feature if high selectivity is required.

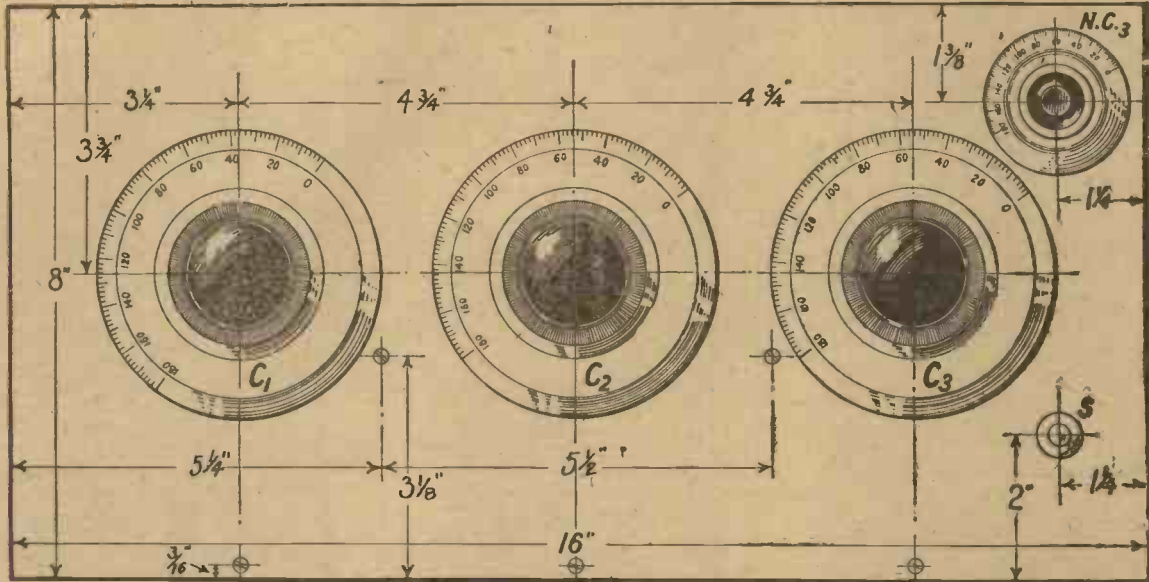
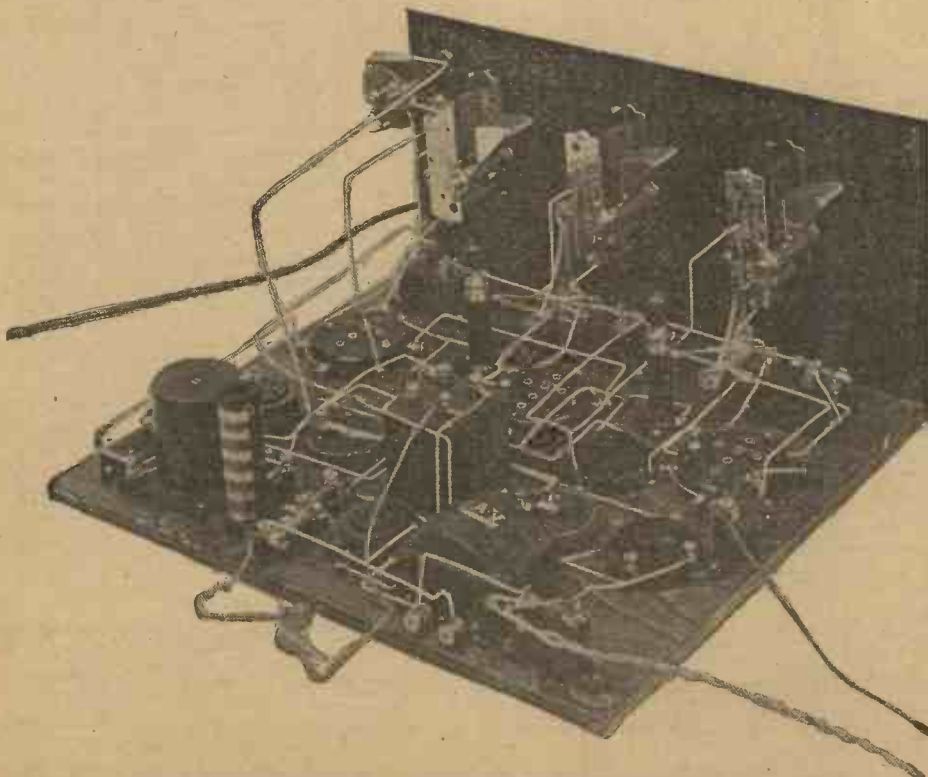

Fig. 3.—The simple layout of the panel makes for ease of construction. Blueprint No. C. 1062A is also obtainable.

ciated aerial, this selectivity is completely discounted if, say, the coil next to the detector itself acts as a

the local station at a distance of, say, 20 miles "without any aerial or earth whatever." This means,



The two leads with winder plugs are for the grid bias battery, which may be placed inside the cabinet.

### BUILD THIS SET WITH—

- One ebonite panel, 16 in. by 8 in. by 3/16 in. or 1/4 in. (Any guaranteed Ebonite)
- One special "All Concert" cabinet, with double depth baseboard (14 in.) to suit (Camco). An alternative cabinet is shown on page 1047 (Peto-Scott Co. Ltd.)
- Three "Eureka Ortho-cyclic" S.L.F. .0005 variable condensers (Portable Utilities Co.).
- Three sets of fieldless plug-in coils with bases (Lissen). (Daventry coils may also be obtained if required.)
- Five "Lotus" anti-phonic valve holders (Garnett, Whiteley & Co.).
- Six fixed condensers .0001, one .0003 with clips, and one .002 (T.C.C.).
- One fixed condenser .0003 type 600 with clips and 2 megohm leak, and one fixed condenser .01 type 610 (Dubilier).
- Two Mansbridge condensers 2 mfd.
- Four "Dumetohm" bases, three .25 megohm and one .5 megohm leaks (Dubilier).
- One panel mounting neutralising condenser (Peto-Scott Co., Ltd.).
- Two baseboard mounting neutralising condensers (L. McMichael, Ltd.).
- One 6-ohm and one 35-ohm baseboard mounting filament rheostat (Lissen).
- One H.F. choke (Varley Magnet Co.).
- One "Success" L.F. choke (Beard and Fitch, Ltd.).
- One all-purpose L.F. transformer (C. A. Vandervell & Co.).
- One push-pull switch (Igranic).
- Two small panel brackets (Burne Jones & Co.).
- Glazite, and flex for leads.
- Approximate cost, complete with valves, L.T. and H.T. batteries and loud-speaker, £20.

# You Can Make the "Night Hawk"

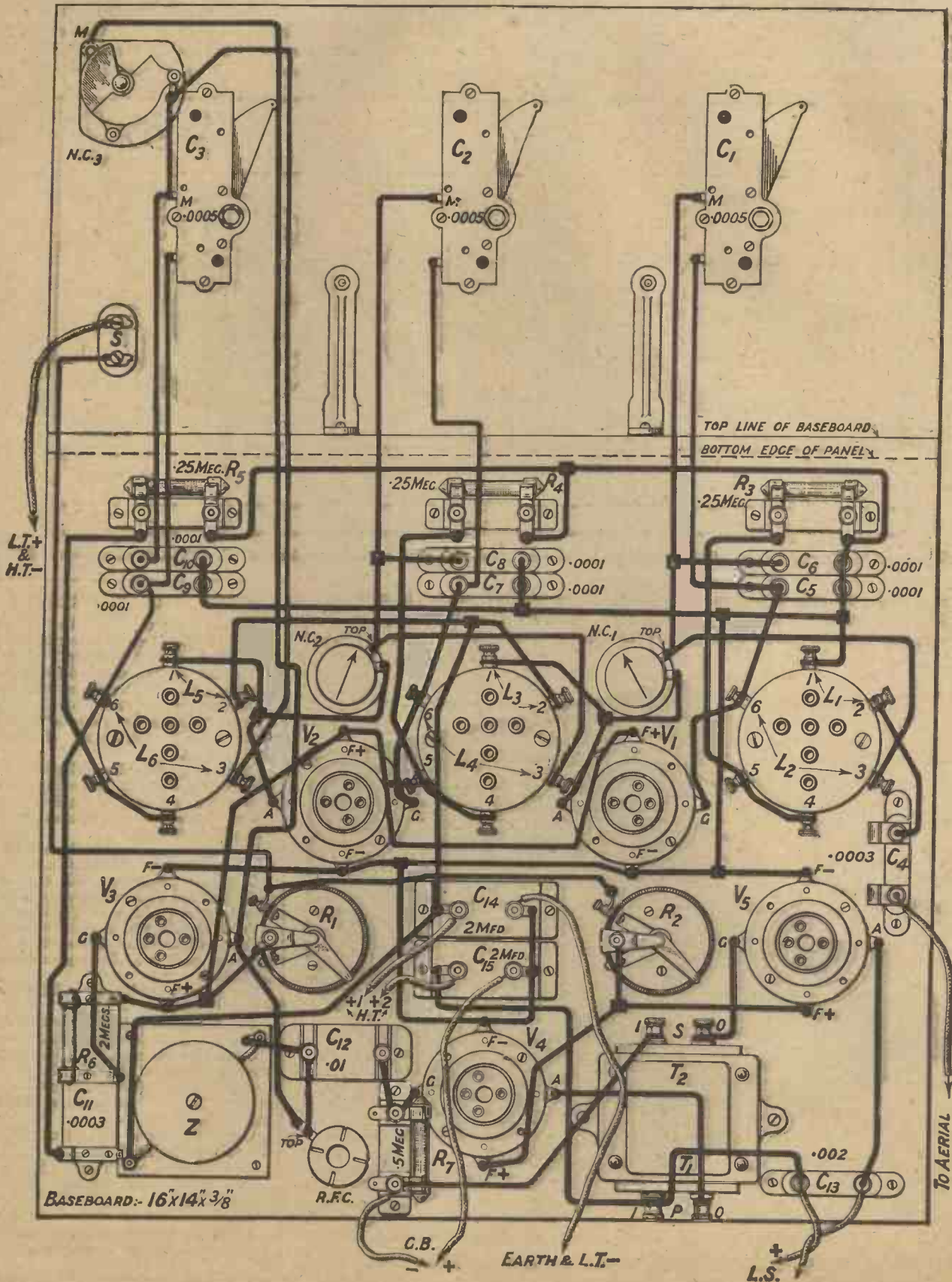

Fig. 4.—Flexible leads from appropriate points are used for making the necessary external connections to the set. Blueprint No. C. 1062B.



## Complete with All Accessories for £20

### Special Coils

Now there are two chief methods of avoiding pick-up in a receiver. One is

It will be noticed that they consist of two insulating tubes stood side by side, each tube carrying two windings,

direction of winding of the two pairs of coils is such that a train of waves from an interfering station falling

#### WIRING IN WORDS

All directions are given as viewing the set from the back.

Join a flex lead to one terminal of fixed condenser C4. This lead is for the aerial connection and passes out through the side of the cabinet.

Join other side of C4 to terminal 2 of right coil base.

Join terminal 1 of right coil base to right contacts of fixed condensers C5 and C6, thence to right contacts of leaks R3, R4, and R5, also to right contacts of fixed condensers C7, C8, C9, and C10, also to one filament contact of valve holders V1, V2, V3, V4 and V5, and to right terminals of fixed condensers C14 and C15.

Join together terminals 4 and 5 of right coil base, thence to left contact of R3.

Join together terminals 4 and 5 of centre coil base, thence to left contact of R4.

Join together terminals 4 and 5 of left coil base, thence to left contact of R5.

Join grid contact of valve holder V1 to terminal 6 of right coil base, thence to left contact of C5.

Join grid contact of valve holder V2 to terminal 6 of centre coil base, thence to left contact of C7.

Join grid contact of valve holder V3 to common contact of fixed condenser C11 and leak R6.

Join other contact of C11 to terminal 6 of left coil base, thence to left contact of C9.

Join remaining contact of R6 to remaining filament contact of V3, thence to one terminal of rheostat R1, also to remaining filament contacts of V2 and V1.

Join remaining filament contacts of V4 and V5 to one terminal of rheostat R2.

Join together remaining terminals of R2 and R1, thence to lower contact of switch S.

Join a flex lead to top contact of switch S. This lead is for connection to L.T. + and H.T. -.

Join terminal 3 of right coil base to top contact of N.C.1.

Join bottom contact of N.C.1 to terminal 1 of centre coil base, and to anode contact of V1.

Join terminal 3 of centre coil base to top contact of N.C.2.

Join bottom contact of N.C.2 to terminal 1 of left coil base, and to anode contact of V2.

Join terminal 2 of centre coil base to terminal 2 of left coil base, also to left terminal of C14 and one terminal of choke Z.

Join remaining terminal of Z to one contact of C12, also to top contact of R.F. Choke.

Join bottom contact of R.F. Choke to anode contact of V3.

Join remaining contact of O1 to one contact of leak R7, and to grid contact of V4.

Join remaining contact of R7 to IS terminal of L.F. transformer T1, T2.

Join OS terminal of T1, T2 to grid contact of V5.

Join anode contact of V4 to OP terminal of T1, T2.

Join IP terminal of T1, T2 to left terminal of C15 and to one terminal of C13.

Join remaining terminal of C13 to anode contact of V5.

Join spindle of variable condenser C1 to top contact of N.C.1 and left contact of C6.

Join fixed vanes of C1 to left contact of C5.

Join spindle of variable condenser C2 to top contact of N.C.2 and left contact of C8.

Join fixed vanes of C2 to left contact of C7.

Join spindle of variable condenser C3 to fixed vanes of N.C.3, also to left contact of C10 and terminal 3 of left coil base.

Join fixed vanes of C3 to left contact of C9.

Join moving vanes of N.C.3 to anode contact of V3.

Join a flex lead to left terminal of C14, for connection to H.T. + 1.

Join a flex lead to left terminal of C15, for connection to H.T. + 2.

Join a flex lead to right contact of C14, for connection to Earth and L.T. -.

Join a flex lead to right contact of C15, for connection to grid bias +.

Join a flex lead to contact of R7 to which T1, T2 is connected, for connection to grid bias -.

Join flex lead to left contact of C13, for loud-speaker +.

Join flex lead to right contact of C13, for loud-speaker -.

to shield the instrument completely in a properly designed metal case which will be impervious to the waves which would otherwise set up currents in the coils and wires of the receiver. A very practical modification of this method is to shield the coils themselves which do most of the picking up. (This method has been developed so excellently by Mr. J. H. Reyner, and is described elsewhere in this issue.)

The other method is to use coils of such a design that they are not appreciably influenced by the waves which may impinge upon them. The coils used in the "Night Hawk" fall under this heading, being of a type which I described last year on my return from America.

a small and a large. The two small windings joined together form the primary and the two larger windings

upon one pair of coils would generate certain potentials across them, but at the same time would set up equal and opposite potentials across the other coils, the windings being so arranged that these two effects cancel out. The effect is practically the same as if the coil were shielded.

### Coil Interaction

Another important point to consider both in shielded coils and in coils of this "Fieldless" type is that interaction between adjacent coils is reduced to a minimum. This has a very important bearing upon the layout of a receiver and enables a far more compact arrangement to be adopted than would otherwise

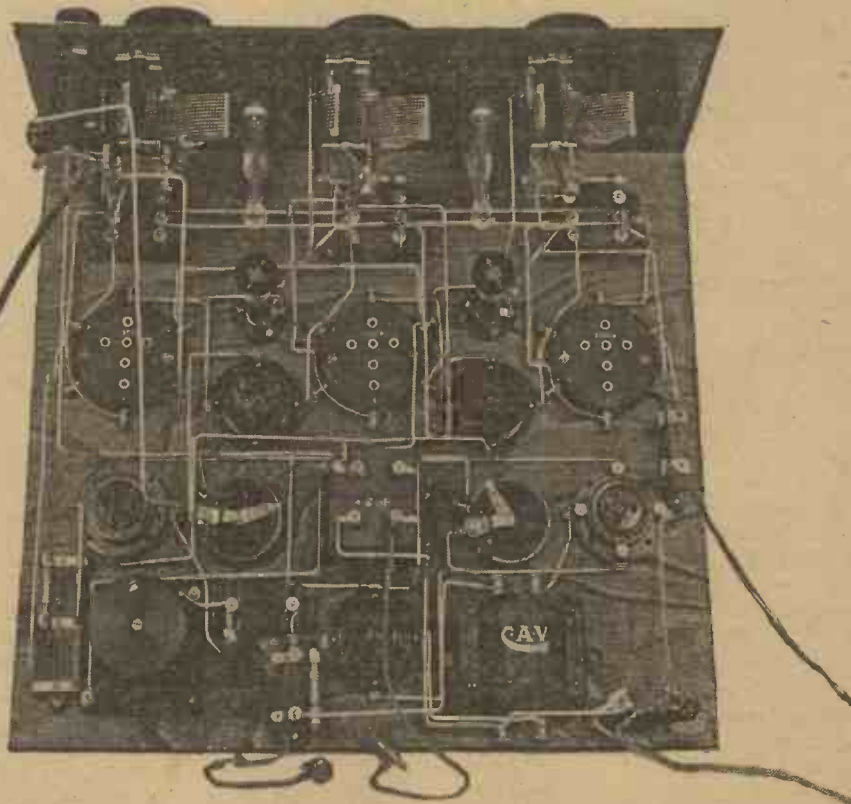

It is important that the disposition of the components shown should be adhered to exactly.

joined together form the secondary of the high-frequency transformer. The

be the case. This accounts for the compactness of the "Night Hawk."

## The "Night Hawk"—continued

### The Circuit

The theoretical circuit illustrated in Fig. 1 is a modification of the now well-known "Elstree Six" circuit, but whereas in the latter double condensers are used with a tapping at the middle point, in the Night Hawk a similar

and although in very many cases this will not be used, as the set will give ample strength without, there are times when on distant stations it will be found most valuable, and in any case it will increase selectivity when razor-sharp tuning is needed.

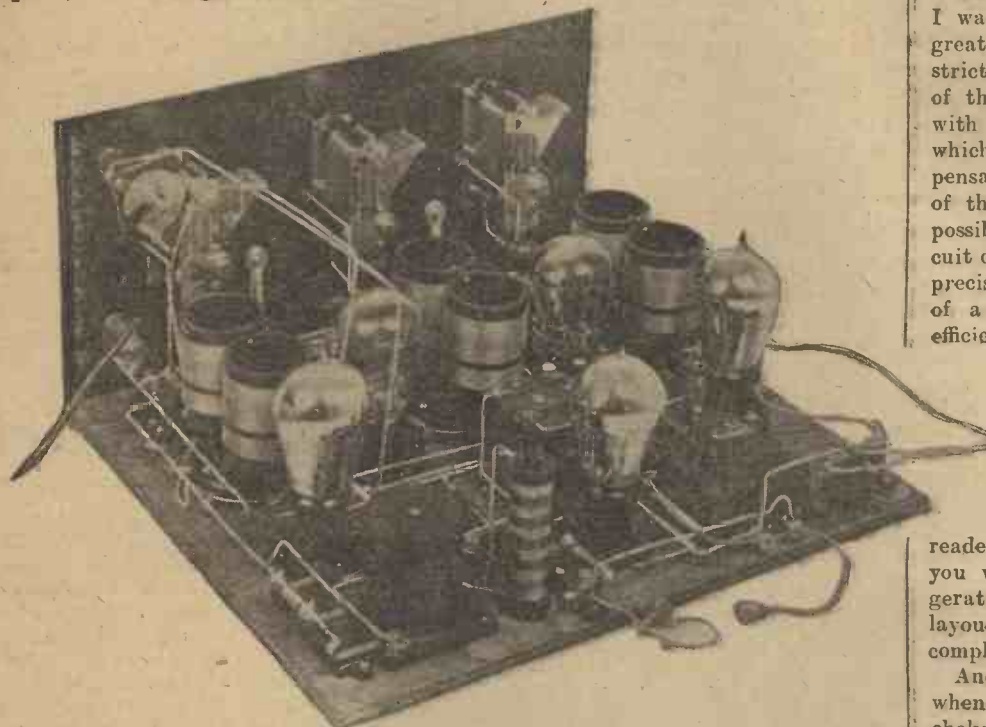

The compact layout of the set will be apparent from this view, showing the valves and coils in position.

effect is obtained by using single variable condensers with two small fixed condensers shunted across them, the tapping being taken at the point of contact between the two condensers. Again, in place of the 100,000-ohm resistances,  $\frac{1}{4}$ -megohm gridleaks are used. Following the detector valve, we have one stage of choke amplification and one stage of transformer-coupled amplification, the combination of the two methods giving particularly good reproduction with a variety of makes of low-frequency transformer.

### Controls

We are now in a position to examine the set more in detail. The front panel carries, as you will see, three dials and a small knob. The first dial tunes the first grid circuit, the second dial the second grid circuit, and the third dial the detector valve grid circuit, as might be imagined. The small knob in the top right-hand corner affords a very delicate reaction control,

### No Special Terminals

You will look in vain for the terminal strip, for there is no such component in the whole set. The abandonment of the conventional terminal strip may be looked upon by many readers as a revolutionary step, but in thinking out the design I realised that by careful layout, not only could the wiring be simplified but expense could be reduced in abandoning the conventional arrangement. Instead of all the leads being brought across the set to one point, thus adding to the complication of wiring, the various components have been so arranged with terminals upon them that leads can be taken straight from vital parts to the outside. The points to which these leads should be attached will be found in the special wiring instructions. The cabinet is provided with drilled holes at the back through which the flexible leads can be taken. It will thus be seen that no leads of any kind disfigure the front of the panel, while

the aerial lead, which for appearance may be made of silk-covered flexible wire, is the only one which is not concealed by the cabinet itself, this passing out through a hole in the side.

### Follow the Instructions

Before starting constructional work, I want to emphasise once again the great importance of following very strictly the exact layout of the wiring of this instrument. In the old days with relatively insensitive receivers in which various losses were crudely compensated for by a further tightening of the reaction setting, it was often possible to interpret a theoretical circuit diagram in a variety of ways with precisely the same results. In the case of a modern sensitive receiver with efficient high-frequency stages, the dis-

position of the wiring may make or mar the success of a receiver, and when I tell you that the functioning, sensitivity and selectivity of the present set were completely changed by what might appear to many

readers to be simple changes of wiring, you will realise that I am not exaggerating when I say that to follow the layout exactly is essential to obtain complete success.

Another interesting point is that when the present radio-frequency choke was substituted for a less efficient type the size of the reaction condenser had to be completely changed. With a less efficient choke, a small variable with several plates had to be used, and its maximum was scarcely enough at the top of the condenser scale to give oscillation control. When the change for a more efficient type was made, the *minimum* of the reaction condenser was found to be too high, and as a consequence it had to be changed for a type with much smaller maximum and minimum capacities.

### Condensers

The set of fixed condensers of .0001 should be ordered matched, and the T.C.C. condensers can be obtained guaranteed with an accuracy of 2 per cent., at a very small increase over the normal cost. Straight-line-frequency condensers are used, as the variables, but it must not be taken as any condemnation of the straight-line-wavelength type. Electrically both will be found equally efficient, but the disposition of wavelength, on the S.L.F. is somewhat different from

(Continued on page 1125.)

# THINGS THAT EVERY OPERATOR SHOULD KNOW

By G. P. KENDALL, B.Sc.

*There are numerous useful hints which the experienced operator can give to those who are new to the art. Mr. Kendall shows in this first article on operation how skilful operating may assist in improving the results obtained from a receiver.*

**D**O you know how to allow for hand capacity in a set which is troubled therewith? Can you decide quickly what is the matter with a set which is afflicted with what is known as "overlap"? Do you know the most certain method of picking up a distant station upon a receiver which has two or three separately tuned circuits? If you do not feel able to answer all these questions with an unhesitating affirmative, perhaps some of the following notes will be of use to you:—

## Hand Capacity

Let us take first the question of hand capacity, by which I mean the question of what to do when operating a set which suffers from this trouble. I do not propose to go into the various methods of removing hand capacity by using the correct connections to variable condensers, employing screens and so on, because these matters have already been dealt with at various times, and it may be assumed that the reader is familiar with them. Nevertheless, it does sometimes happen that one is presented with the problem of operating a set in which hand capacity effects are bad, and in which there is no time to make alterations.

## What it is

Let us make quite sure that we understand exactly what is meant by "hand capacity." Strictly speaking, these are effects taking the form of alteration of tuning when the hands are placed upon certain of the operating controls, usually the dials of the variable condensers. This alteration is the natural result of the fact that the hands of the operator possess a certain capacity to the various parts in the set, so that they upset the tuning when placed in close proximity to those parts. For example, when you place your hand upon a variable condenser you add a certain small amount to the capacity of that condenser, and so alter the tuning of the circuit in which the component is situated.

## The Usual Effect

In most cases, then, we may take it that the effect of placing one's hand upon one of the operating controls is to add capacity to the circuit, and therefore to increase the wavelength to which it is tuned. With this fact in mind, it becomes easy to see how we may allow for these objectionable effects in tuning, and so adjust our sets that when the hands are removed, they will be found to be correctly tuned to the desired station.

## The First Step

The first thing to be done is obviously to discover how much capacity is added to the circuit when one places one's hand upon a variable condenser, and this is fairly easily done. With one of the receivers of the latest non-radiating variety—that is to say, one in which it is possible to make one of the circuits oscillate without danger of causing interference—the procedure is as follows:—Tune in a distant station and throw the non-radiating

what pitch the squeal rises as a result of the alteration of tuning produced by taking the hand away. Place the hand upon the condenser once more and increase its reading until you hear a squeal of the same pitch as you previously heard. Now remove the hand once more, and the squeal should die down again to the silent point if you have correctly estimated the note.

You will soon discover how much to increase the condenser, in order that the carrier-wave may be heard at its silent point when the hand is removed, and this difference of reading should be noted, being found to be perhaps  $1\frac{1}{2}$  degrees. Then simply regard this figure as a sort of correction factor to be used when operating that particular dial, and whenever you find a station, simply add on the correction to the apparent reading, and when you remove your hand you should find that the station will be heard properly.

## Another Method

Having discovered the correction factor for the dial of the condenser



*"In tuning a two-dial set, the procedure is to set one dial at zero and revolve the other slowly and carefully throughout its scale."*

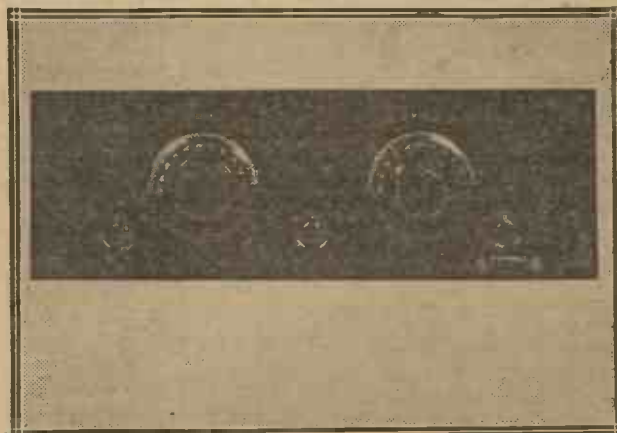

part of the set into oscillation. Now, with the hand upon the tuning condenser of the circuit which is oscillating, proceed to tune in to the silent point of a carrier-wave. Next, lift the hand off the condenser and note to

tuning the circuit in the set which it is permissible to set into oscillation, it is necessary to discover the correction for the other dial, which will probably be that of the condenser tuning the aerial or secondary circuit. It

THINGS EVERY OPERATOR SHOULD KNOW—continued

is not possible to adopt the same scheme here without causing interference, so a little trial and error is needed, increasing the reading of the condenser a fraction of a degree at a time, removing the hand each time, and noting whether the signals come in properly when the hand has been taken away. A setting will soon be discovered at which signals are heard correctly, and disappear again when

circuits are maintained in resonance with each other as searching proceeds, a gradual sweep over the various wavelengths of search being made.

For example, in a set with two tuned circuits, the procedure is to set the two dials at such readings that the two circuits are in tune with each other, and then to proceed to vary them, simultaneously, keeping them in tune with each other as this is done. To



Is "looking-in" to become a wide-spread pastime? Here is a television receiving station, which is now in operation on Mr. J. L. Baird's system.

the hand is replaced; the difference between this reading and that given when the hand is placed upon the condenser and the adjustment of the condenser altered to bring in the signals once more should be duly noted, for this is our correction factor.

**Simplified Operating**

When you have obtained the appropriate correction figure for each of the dials in your set, tuning-in the distant stations becomes quite a simple matter, even when hand capacity effects are relatively bad, for you simply tune-in with your hands upon the dials, add the appropriate amount to the readings, remove your hands, and there is the station. In the case of sets which it is not permissible to use in the oscillating condition for the determination of the correction factor, of course, you can employ the other method described for the first circuit of a non-radiating type of set, and you will soon obtain the desired information.

**Searching**

Now, what about methods of searching? There are two principal methods of searching, one which can be used when you are thoroughly familiar with the set, and the other, one which most of us have to employ at times when using sets with which we are not well acquainted. The first is the method of rotating the various dials simultaneously in sympathy with each other in such a way that the several tuned

do this one must become acquainted with the sound heard when the two circuits are in resonance, and this again is not, as a rule, a difficult matter to discover. Generally, there will be a faint sound of "liveliness," as it were, made up of a slight crackle of atmospherics, stray Morse signals, and so on, and it is possible to follow this sound round upon the dials with just a little practice.

**An Alternative**

This is a method which is familiar to most people, and can be learned by anyone with a little practice, but it may perhaps be useful to explain the other method, which can be used without any practice, even upon a new and unfamiliar receiver. The scheme is simply to adopt a method of varying the readings of the dials progressively in such a way that all the possible combinations are tested in turn until the correct one for the desired station is found:

In a two-dial set, for example, the procedure is to set one dial at zero and revolve the other slowly and carefully throughout its scale. If nothing is heard, advance the first dial a couple of degrees, and try again, proceeding in this way until all possible combinations of settings have been tried. (In a very sharply-tuned receiver, of course, it may be necessary to advance one of the dials in steps of one degree at a time instead of two, lest a station be missed.)

AN IMPROVEMENT WORTH TRYING.

WHEN it becomes necessary to mount a two- or three-way coil holder on the outside of a wireless cabinet, leads from the coil connections are generally taken through holes in the cabinet side to their correct positions in the receiver. If the receiving set is designed with the upright panel and baseboard, each time the set is taken from its case the leads under the screw heads in the coil blocks must be released and pulled through the holes in the cabinet before attempting to slide out the panel and baseboard.

To avoid this, it will be found quite useful to mount a pair of terminals

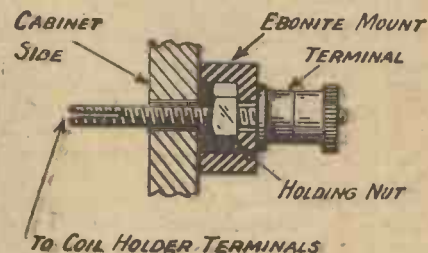

Fig. 1.—The ebonite strip carrying the terminals is screwed to the outside of the cabinet.

on ebonite strip, as indicated in Fig. 2. The nuts holding the terminals fit into holes recessed in the ebonite, while the terminal shanks pass through holes with a reasonable clearance in the side of the cabinet. Two terminals should be mounted inside the cabinet for each coil block, and then short, flexible leads from the coil screws can be taken and soldered on to the terminal shanks. The leads inside the receiver can now be taken to the terminals, and are easily loosened when withdrawal of the set from the cabinet is desired.

THE ELSTREE "SOLODYNE"

Five Valves—One Dial—Fifty Stations on the Loud-Speaker.

Complete instructions for building this "Wonder Set" are to be found in the September issue of

'MODERN WIRELESS'

SPECIAL AUTUMN DOUBLE NUMBER

On Sale Now - Price 1/6

**A**

According to Homer, Stentor was the name of a Greek herald in the Trojan War whose voice was as loud as that of 50 other men combined. As the name for a new Cossor Power Valve it is, therefore, peculiarly appropriate.

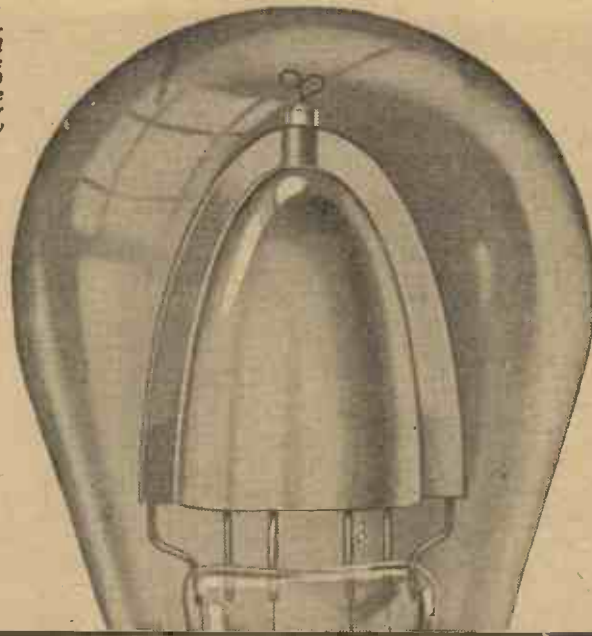

## Already a sensational success

ALREADY technical experts and radio journalists are enthusing over the new series of Cossor "Point One" Valves. "The best Valves Cossor has ever made," said one, whose name is a household word among home constructors. "These new Cossor Point One valves have quite converted me to the 2-volt idea," writes another prominent radio journalist. "Your new Valves prove that this country has nothing to learn from other nations in valve design," is an extract from a letter recently received from a third expert.

We could quote numerous other letters in similar strain, and it is significant that many of those who have taken the trouble to write to us during the past two or three weeks are men who have grown up in the wireless industry.

Men whose seasoned judgment in radio technique is invaluable—men who are not easily roused to enthusiasm by the introduction of a new valve.

They are the men who are the pace-makers of the whole Radio industry—their opinions are the straws which show which way the wind is blowing. And there is unmistakable evidence that the



### The wonderful new Cossor "Point One" Dull Emitters

- Plain Top:  
For Detector or L.F. . . . . 14/-  
(Consumption '1 amp.)
- Red Top:  
For H.F. use . . . . . 14/-  
(Consumption '1 amp.)
- Stentor Two  
For Power use . . . . . 18/6  
(Consumption '15 amp.)

All operate at a voltage of from 1/2 volts to 2 volts.

new Cossor Point One has been given warmth of welcome accorded to no other valve. Wireless enthusiasts have been quick to realise the importance of the wonderful new system of Coaxial Mounting, which ensures perfect uniformity of characteristic between all valves of the same class. An exclusive Cossor feature. The broadcast listener, tired of frequent replacements, has appreciated the tremendous advantage of a shock-proof filament system which ensures an incredibly long life. While its exceptional economy in current consumption (the new Cossor Point One consumes only .1 of an ampere at 1.8 volts) proves that there is now available a valve capable of giving superb results from ordinary dry batteries.

When your present valves become useless, choose the new Cossor Point One Series—the only valves in the world to utilise Coaxial Mounting. We can promise you a new pleasure in Radio—greater volume—improved stability—a fidelity of reproduction that will astound you—an increased sensitiveness that will add miles and miles to the range of your Set. And remember, finally, the prestige enjoyed by Cossor—the good name that stands squarely at the back of every Cossor Point One and Stentor Two.

# Cossor Point One

Issued by A. C. Cossor, Ltd., Highbury Grove, London, N5.

Gilbert Ad. 5638

In replying to advertisers, please mention THE WIRELESS CONSTRUCTOR.



## A TRIUMPH FOR ELSTREE

### 2 VALVES GIVE 20 STATIONS ON THE LOUD-SPEAKER

Full Instructions for You to Build

The "DISTAFLEX TWO"—An Elstree Star Set

Described by J. H. REYNER, B.Sc. (Hons.), A.C.G.I., D.I.C., A.M.I.E.E.

**Q**UITE early in the history of broadcasting the possibility of utilising one valve to perform the double purpose of amplifying both at high frequency and low occurred to the designers of receiving sets, and for some time there were many varieties of dual amplification or reflex circuits. The outstanding example of this class of receiver was the S.T.100, designed by Mr. John Scott-Taggart, which achieved considerable popularity, and indeed is still treated by many as the standard two-valve set.

#### Modern Requirements

Since the early days, however, considerable development has been made in the art of high-frequency amplification. The increasing number of stations working in Europe generally has resulted in the possibility of a large number of different programmes

being received as well as that from the local station. Before such stations can be satisfactorily received, however, two essentials have to be fulfilled.

In the first place the receiver must be able to eliminate the local station within a few degrees on the dial, and so receive the distant stations without excessive jamming. In order to obtain really good selectivity, and to enable practically every other station to be tuned in without any interference from the local station, a very efficient tuning system is required.

#### Moderate Selectivity

There are many people, however, who do not require the degree of selectivity which is necessary to receive stations working on wavelengths only a few metres different from the local station, and are quite satisfied with a reasonable degree of selectivity only, which will permit the reception of 15

to 20 stations on the loud-speaker free from interference. At the same time a certain amount of selectivity is necessary to separate the various distant stations which are working so close together that they will jam each other on an ordinary simple circuit.

#### The Demand for Economy

These conditions can be complied with in an ordinary five-valve receiver comprising two stages of high-frequency, a detector, and two stages of low-frequency amplification. For some people, however, a set of this description is not feasible. The cost of running demands a large accumulator and a high-tension battery of ample capacity, while of course the fact that five valves are required is also a point for consideration.

If it were possible to obtain results comparable with those from an ordinary five-valve receiver with a

## The "Distaflex Two"—continued

smaller number of valves, utilising the reflex principle, then there is no doubt that the reception of these distant programmes would become a much more practical proposition to many people.

the left-hand figure (a) we have a simple tuned circuit. The middle tapping of the coil is at a potential midway between the potentials of the two ends. There is obviously some similar point in the middle of the

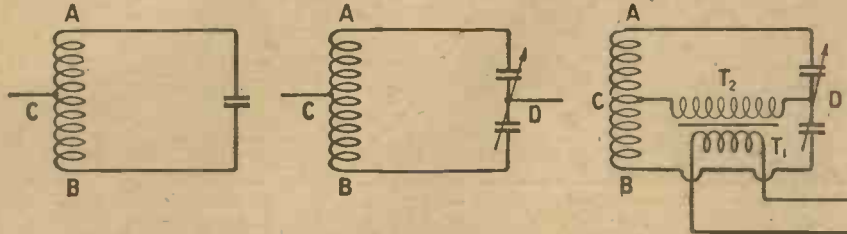

Fig. 1 (a, b and c).—Illustrating the new reflexing principle which is used in the receiver.

### Two Valves for Five

With this end in view some extensive research work has been conducted at the-Elstree Laboratories to produce a receiver comprising two high-frequency stages, a crystal detector, and two low-frequency stages, two valves only being utilised and made to perform the double function of high- and low-frequency amplification.

### A New Principle

This has been rendered possible by the use of an entirely new principle of reflexing. It is necessary that the presence of the low-frequency transformers utilised in the receiver shall

condenser somewhere, and these two points would therefore be at the same potential.

In order to obtain this centre tapping on the condenser, we utilise a dual condenser for tuning, when the two points, the centre-tap on the coil, and the middle point on the condenser are both at the same potential, and we can therefore connect our low-frequency transformer across these points as shown in Fig. 1 (b).

### Separating H.F. and L.F.

Since, both valves are carrying both high-frequency and low-frequency currents, it is necessary to obtain some

the receiver, the complete circuit being as shown in Fig. 3. The three tuned circuits are each tuned with a dual condenser, a crystal detector being connected across the last tuned circuit. In order to minimise damping as far as possible, the detector circuit is only connected across one-half of the coil instead of the complete coil. A jack is inserted in series with the detector, so that telephones may be plugged in at this point with the receiver working as a simple two H.F. and detector circuit. On withdraw-

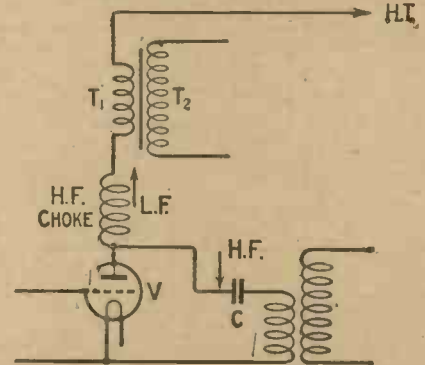

Fig. 2.—The separation of the H.F. and L.F. currents is achieved, an H.F. choke being used in the anode circuit.

ing the telephones, the primary of the first transformer is connected in circuit, and the receiver operates as a reflex.

## TWENTY STATIONS ON THE LOUD-SPEAKER.

The following stations were received on a simple 60ft. aerial, 20ft. high, the strength in all cases being sufficient to operate a loud-speaker.

The dials read approximately together, although a slight difference of 1 or 2 degrees may be observed at certain points of the scale.

Station.	Dial Reading.	Station.	Dial Reading.	Station.	Dial Reading.
Liege ... ..	54	Manchester (slight interference by London) ... ..	88	Muenster ... ..	99
Hanover ... ..	59	Oslo ... ..	90	Glasgow ... ..	101
Dundee ... ..	63	Bournemouth ... ..	91.5	Radio Toulouse ... ..	103
Nottingham ... ..	70	Dublin ... ..	94	Belfast ... ..	106
Hull ... ..	72	Newcastle ... ..	98	Leipzig ... ..	112
San Sebastian ... ..	78			Frankfort ... ..	115
London ... ..	82			Birmingham ... ..	117
				Aberdeen ... ..	122.5

in no way affect the high-frequency tuning circuits, in order that the necessary selectivity and high-frequency amplification may be unimpaired. If we could connect the low-frequency transformers across two points in the circuit which were always at the same high-frequency potential, we should achieve this object, and this is the principle which has been adopted.

### The Circuit

The development of the circuit is shown diagrammatically in Fig. 1. On

method of separating these currents in the anode circuit. In order to achieve this, therefore, a choke feed has been obtained. The principle adopted is illustrated in Fig. 2. The high-frequency currents go through the small condenser C and the primary of the H.F. transformer on to the next valve, while the low-frequency currents pass through the high-frequency choke and the primary of the L.F. transformer.

### Alternative Circuits

These are the essential principles in

### Neutralised H.F. Stages

The secondary of the first transformer is connected in the grid circuit of the first valve, after which the low-frequency currents pass through the paths allotted to them and are taken off from the anode of the second valve. In this latter circuit an alternative jack or telephone connection is provided, so that tuning-in may be carried out on the telephones if desired, when a removal of the plug will place the station on the loud-speaker.

# The "Distaflex Two"

Both the high-frequency circuits are neutralised, the second neutralising condenser being mounted on the panel in order to provide a reaction control.

In marking out the panel, of course, all scriber lines should be made on the back of the panel, so that the positions of the components will be

minerals in the middle for the L.T. and H.T. batteries. In order to simplify matters, only one high-tension battery tapping has been used.

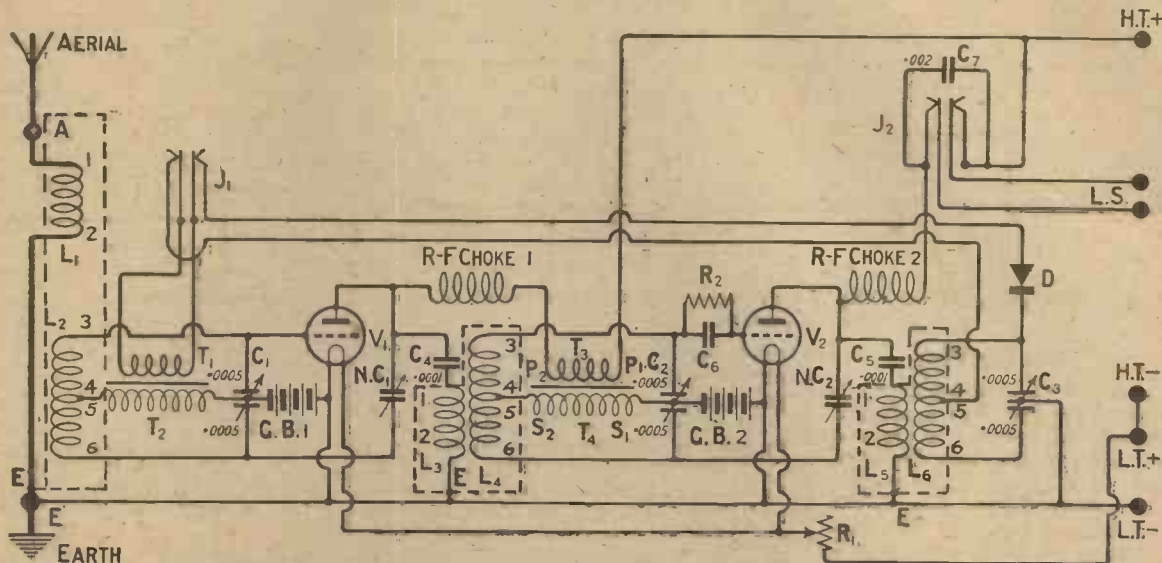

Fig. 3.—The complete circuit of the "Distaflex Two." The dotted lines represent the screens of the screened coils, the windings being numbered to correspond with the numbered terminals on the coil bases.

### Constructional Details

The first procedure is the mounting of the three dual condensers, the filament rheostat, the panel-mounting neutralising condenser, the two double circuit jacks, and the crystal detector upon the main panel. The positions of these components will be seen

reversed, and this should be borne in mind when this operation is carried out.

### Terminals

The next operation is the drilling of the terminal strip which runs along the whole length of the back of the set. Holes should be drilled for the

The panel may now be screwed into position on the baseboard, and the baseboard components laid out in their appropriate positions. The three coil screens are mounted behind the respective condensers, the distance apart being a little greater than that between the condensers, as shown. The two L.F. transformers are mounted in the space between the variable condensers, as will be seen from the layout provided. The remainder of the components can be fitted in the positions shown without any difficulty, and when all the components have been suitably spaced they may be screwed into position.

### Wiring

The receiver is now ready for wiring up, and little difficulty will be experienced as every component is readily accessible. It is advisable to remove the covers from the screened coils and also the coils themselves during the wiring-up process, as this enables one to obtain easier access to the terminals on the base. In some cases it has been found that in transit the terminals on the base of the screens become slightly loose, and as this would give rise to a fault when the receiver is completed, each unit should be examined carefully to ensure that this has not happened. It is better to make sure of this point when commencing to wire up the set rather than to discover it later on, and have to dismantle a portion of the receiver in order to put the matter right.

The filament circuit may be wired first, after which the connections to

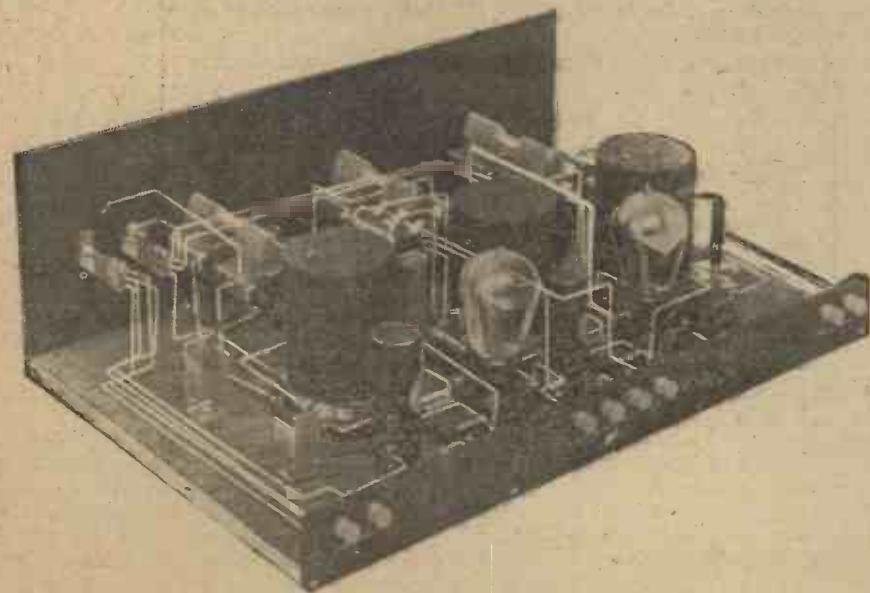

The terminals are carried on a strip of ebonite which runs for the full length of the baseboard.

clearly from the panel diagram supplied, which gives the positions of the holes looking from the front of the panel.

eight terminals necessary in the positions shown. The right-hand pair are for the aerial and earth, the left-hand the loud-speaker, and the four ter-



## A Star Set of Universal Appeal

the screened coils may be made. The high-frequency side of the circuit may be wired almost completely without troubling about the low-frequency

After the high-frequency wiring has been completed, the necessary connections to the low-frequency transformers and jacks may be made, and

### Valves to Use

The principal difficulty with this receiver had been, that of rendering it

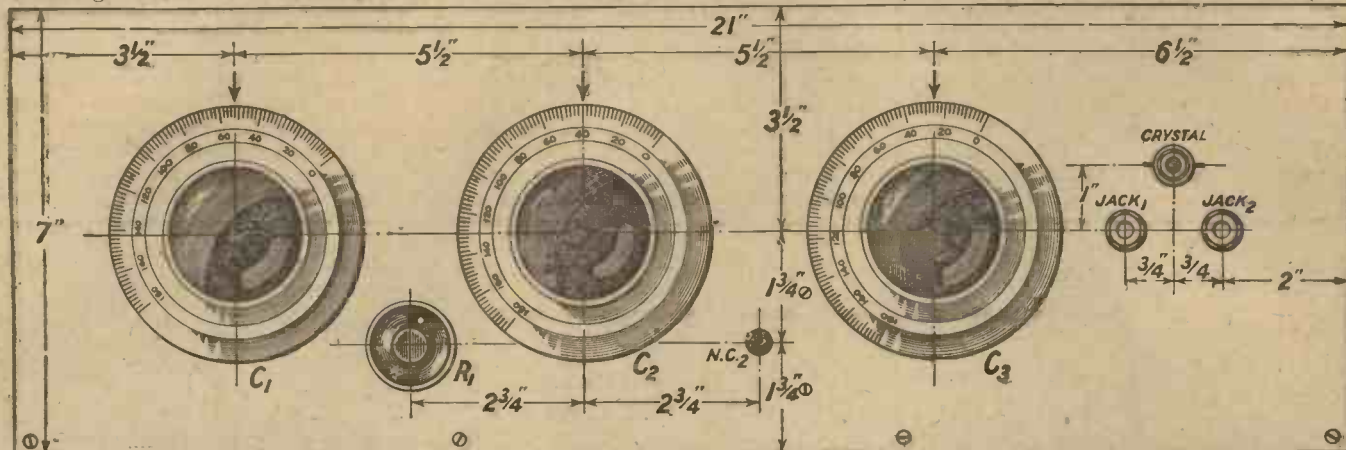

Fig. 4.—The drilling layout of the panel is simple, only one filament rheostat being employed. Blueprint No. C.1063A.

side, which is to all intents and purposes a separate circuit.

### BUILD THIS SET WITH—

One ebonite panel, 21 in. by 7 in. by 1/4 in. (Clayton.)

One cabinet to suit with baseboard 13 1/2 in. deep. (A cabinet with two glass panelled doors, which makes a very attractive finish, is supplied by Messrs. Caxton Wood Turnery Co., Ltd.) That shown on page 1056 is of different make.

Three .0005 dual condensers (Collinson) with 4 in. dials.

Three split-secondary transformers, 250 to 550 metres. (Davenport coils may be obtained if desired.)

Three coil screens and bases. (Burne-Jones & Co.)

Two vibratory valve holders. (Benjamin.)

Two H.F. chokes. (Lissen, Ltd.)

One baseboard-mounting neutralising condenser. (Bowyer-Lowe Co.)

One panel-mounting neutralising condenser. (Bowyer-Lowe Co.)

One all-purpose L.F. transformer. (Ferranti.)

One 2nd stage L.F. transformer. (In this case an R.L. multi-ratio has been adopted, so that the most suitable ratio can be chosen.)

One filament rheostat. (C.A.V.)

Two double circuit jacks. (Bowyer-Lowe Co.)

One panel mounting crystal detector. (R. I., Ltd.)

Two .0001 fixed condensers. (Dubilier Co.)

One .002 fixed condenser. (Dubilier Co.)

Two pairs grid bias battery clips. (A. F. Bulgin.)

One .0003 fixed condenser with 2 megohm leak. (T. C. C.)

One ebonite strip, 21 in. by 2 in. Eight terminals.

A quantity of Glazite and a short length of flex.

Radio Press panel transfers. Approximate cost, £6.

this will complete the wiring of the receiver.

When the receiver has been completely wired, it may be placed on test and the necessary preliminary adjustments made. The first thing to do is to place the three H.F. transformers in position in the screening coils, and to place the shields over the coils. Care must be taken that the shields make a good tight fit with the cases. In some instances it is found that all

capable of handling the large volume from the local station. With an efficient high-frequency amplifier such as we have here, the signal strength applied to the detector is considerable, and the two dual valves therefore have to handle a very large H.F. current and a still larger L.F. current superimposed.

It is thus essential to utilise a valve having a very long characteristic. A low-impedance type of power valve is

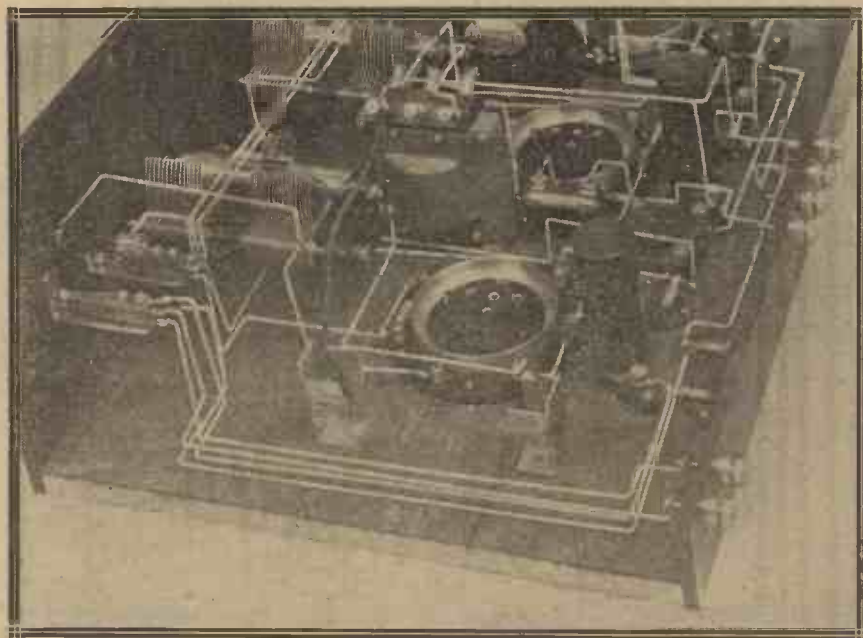

This photograph shows clearly the arrangement of the wiring to the jacks and terminals.

the screens are not exactly interchangeable, so that when a screen is removed from its base it should be returned to its correct position and not placed on any other base.

essential, therefore, and in fact if the receiver is to be used close to a local station, it is desirable to use a valve having an even lower impedance than usual,

# The "Distaflex Two"

### With Other Valves

This is not absolutely necessary, however, unless exceptional volume is required from the local station. With an ordinary low-impedance valve there will be a tendency to blast when receiving very loud signals, owing to the fact that the valve cannot handle the volume, and this may be cured either by dimming the filament slightly by means of the filament rheostat provided or by mistuning the aerial circuit.

### A Limiting Device

The grid condenser and leak, which is provided in the grid lead of the second valve, is to some extent a preventive of this blasting. The position of this component may have occasioned some surprise, since the rectification in the receiver is provided by a crystal.

The function of the condenser and leak in this case is not to provide any rectification, and in fact it does not do so, because the return circuit of

this grid is connected to a considerably negative potential. It acts rather as a limiting device on very strong signals, tending automatically to increase the grid bias potential and to minimise the blasting.

### Grid Bias and High-Tension

The grid bias which is provided on each of the valves should be considerable, the actual value depending upon the valve in use and the high-tension voltage. Owing to the large volume

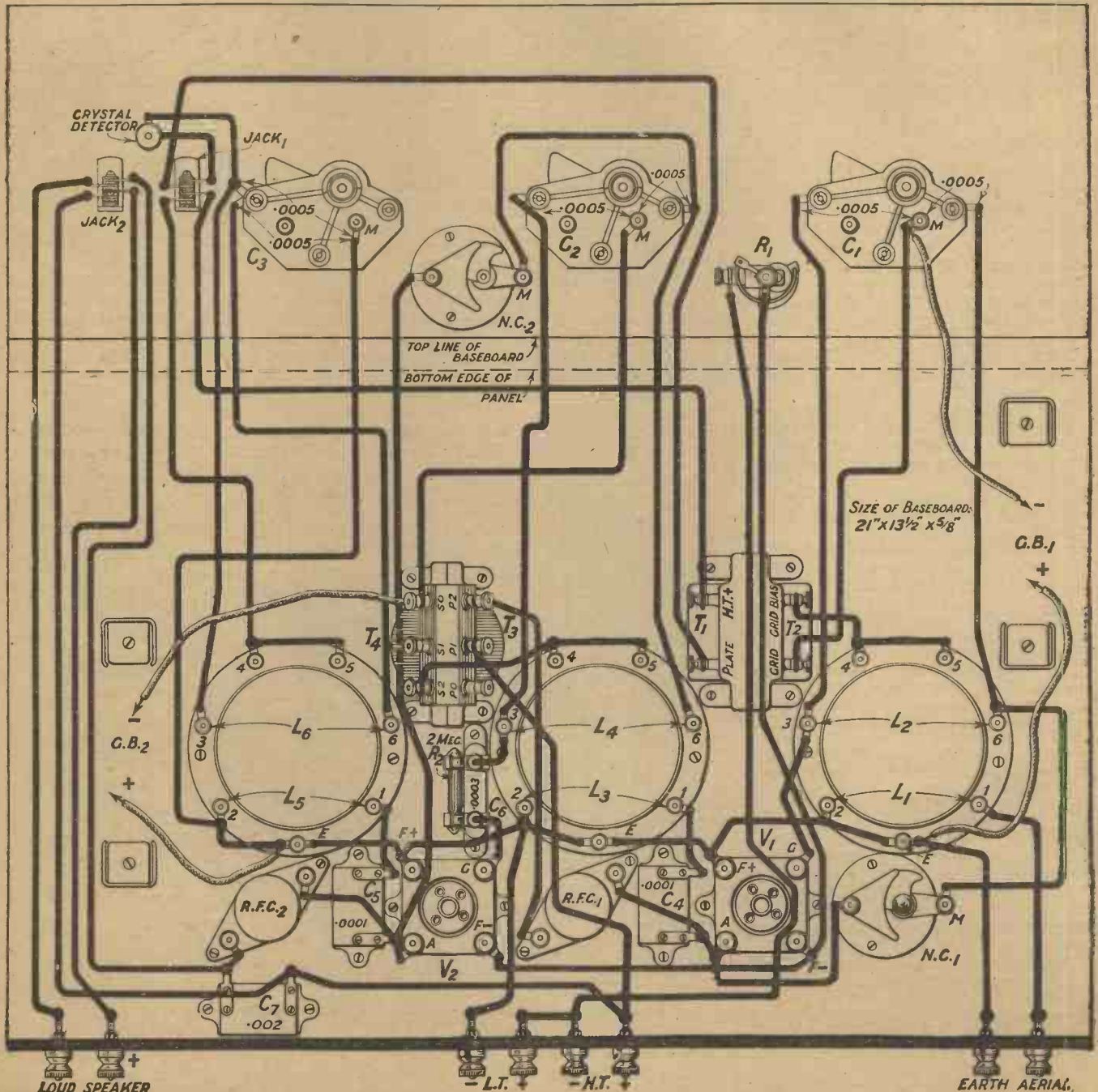

Fig. 5.—A useful check may be kept on the wiring by crossing out each connection in the instructions on the opposite page as it is completed. Blueprint No. C.1063B of this diagram may also be obtained.

## Begin and Build It Now

which these valves have to handle, it is advisable to use as large a high-tension voltage as practicable, about 100 or 120 volts being satisfactory for ordinary purposes. With such volt-

low-frequency oscillation. When this receiver is correctly adjusted it will be found that all signals cease when the crystal is removed. There may be a very faint background of signals

Place both of the neutralising condensers about one-third of the way round, and then tune in to the local station. No sign of oscillation should be observed, but if the set tends to

### WIRING IN WORDS

All directions are given as viewing the set from the back.

Join Aerial terminal to terminal 1 of right-hand coil base.

Join Earth terminal to terminal E of right-hand coil base, thence to terminal 2, to one filament contact of V1 valve holder, to terminal E and terminal 2 of centre coil base, to one filament contact of V2 valve holder, to terminal E and terminal 2 of left-hand coil base, and to spindle of variable condenser C3.

Join H.T. positive terminal to P1 terminal of L.F. transformer T3 T4, also to one side of fixed condenser C7 and thence to bottom contact of Jack 2.

Join H.T. negative terminal to L.T. positive terminal and to one terminal of filament rheostat R1.

Join L.T. negative terminal to terminal 2 of centre coil base.

Join right-hand loud-speaker terminal to lower right-hand contact of Jack 2.

Join left-hand loud-speaker terminal to upper left hand contact of Jack 2.

Join top contact of Jack 2 to one side of R.F. choke 2 and to remaining side of fixed condenser C7.

Join inner (nearest panel) fixed vanes of variable condenser C1 to terminal 6 of right-

hand coil base, and thence to moving vanes of condenser N.C.1.

Join moving vanes of C1 to Grid terminal of L.F. transformer T1 T2.

Join Grid bias terminal of T1 T2 to terminals 4 and 5 of right-hand coil base.

Join outer fixed vanes of C1 to terminal 3 of right-hand coil base, and thence to grid contact of V1 valve holder.

Join remaining terminal of filament rheostat R1 to remaining filament contacts of V1 and V2 valve holders.

Join inner fixed vanes of variable condenser C2 to terminal 6 of centre coil base, and also to moving vanes of condenser N.C.2.

Join spindle of C2 to S0 terminal of L.F. transformer T3 T4.

Join outer fixed vanes of C2 to terminal 3 of centre coil base, and thence to one side of fixed condenser C6.

Join other side of C6 to grid contact of valve holder V2.

Join terminal 1 of centre coil base to one side of fixed condenser C4.

Join other side of C4 to anode contact of valve holder V1, thence to fixed vanes of condenser N.C.1, and to one side of R.F. choke 1.

Join other side of R.F. choke 1 to P2 terminal of L.F. transformer T3 T4.

Join terminal S2 of T3 T4 to terminals 4 and 5 of centre coil base.

Join fixed vanes of condenser N.C.2 to anode contact of valve holder V2, also to one side of fixed condenser C5 and to remaining side of R.F. choke 2.

Join remaining side of C5 to terminal 1 of left-hand coil base.

Join inner fixed vanes of variable condenser C3 to terminal 6 of left-hand coil base.

Join outer fixed vanes of C3 to one side of crystal detector, and also to terminal 3 of left-hand coil base.

Join other side of crystal detector to top contact of Jack 1.

Join bottom contact of Jack 1 to terminals 4 and 5 of left-hand coil base.

Join upper left contact of Jack 1 to Plate terminal of L.F. transformer T1 T2.

Join H.T. + terminal of T1 T2 to lower right contact of Jack 1.

Attach flex leads with battery wander-plugs to the following points: spindle of variable condenser C1; terminal E of right-hand coil base; S0 terminal of L.F. transformer T3 T4; terminal E of left-hand coil base.

ages from 6 to 9 volts negative at least is required on each valve grid in order to avoid blasting, and also to avoid rectification by the valves themselves.

when receiving the local station, but on other stations no signals whatever will be heard.

Having chosen the valves and bat-

teries, therefore, the telephones should be inserted in the No. 1 jack. This connects up the receiver as a straightforward 2 H.F. and crystal circuit. oscillate at any point, one or other of the neutralising condensers should be adjusted slightly until no such oscillation is produced.

\* \* \*

The correct lay-out of the components and wiring is of great importance, and this view should furnish useful supplementary information to Fig. 5.

\* \* \*

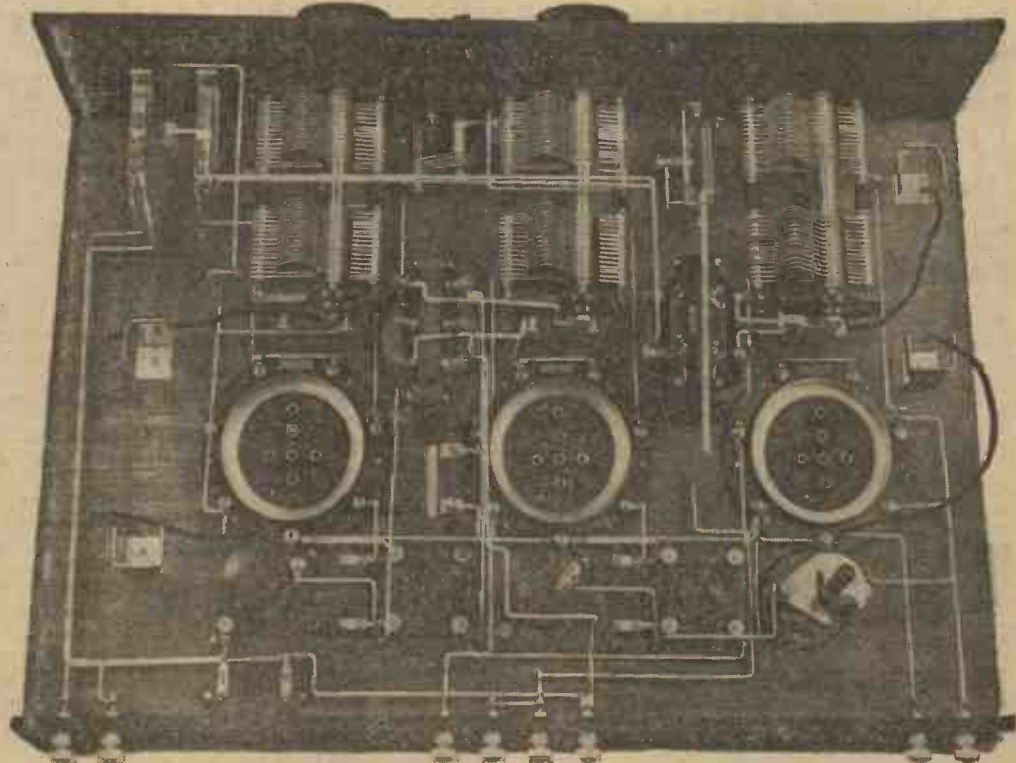

### Final Adjustments

As with all reflex circuits, the dual valves must not be allowed to rectify, as otherwise there is a tendency to

teries, therefore, the telephones should be inserted in the No. 1 jack. This connects up the receiver as a straightforward 2 H.F. and crystal circuit.

### Neutralising

Then move the dials in unison, that is to say, keeping the dials approximately the same from top to bottom

THE DISTAFLEX TWO—continued

of the scale, swinging the aerial condenser over 5 or 10 degrees on either side of the actual tuning point, and noting whether any tendency to oscillate is observed. If the receiver bursts into oscillation, this should be

being that two note-magnifying valves have been added. It is a good plan, therefore, to search for the various stations required with the telephones in jack No. 1 until some skill in the use of the three dials is acquired.

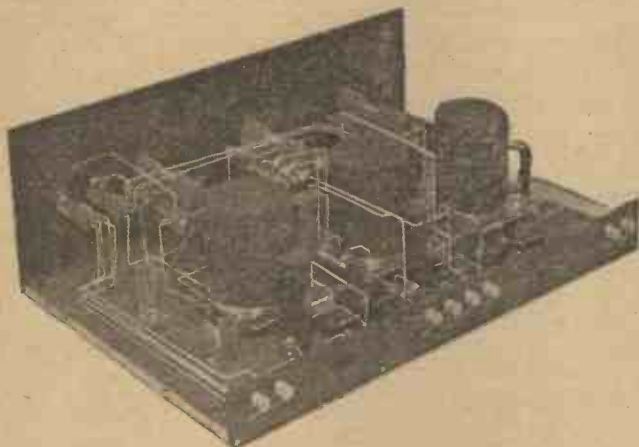

\* \* \*  
*The neutralising condenser mounted on the baseboard is set when the receiver is first tested, and then left, the panel neutralising condenser being used for reaction control.*  
 \* \* \*

checked by a slight movement of the neutralising condensers one way or the other, and by this means a position will readily be found in which the receiver is stable over the whole range. The baseboard-mounted condenser is then left fixed, while the panel-mounted condenser is utilised to apply deliberate reaction.

**The L.F. Stages**

The telephones may then be removed from jack No. 1 and inserted in jack No. 2, when the reflex portion of the circuit will come into operation, and

As long as the three dials are rotated exactly together little difficulty will be experienced in finding the stations. The aerial dial will be found to be slightly different from the other two owing to the effect of the aerial capacity, but this is usually only a matter of two or three degrees, and the correct tuning positions will readily be found.

**Stations Heard**

The approximate positions of the various stations will be shown from the accompanying test report, which

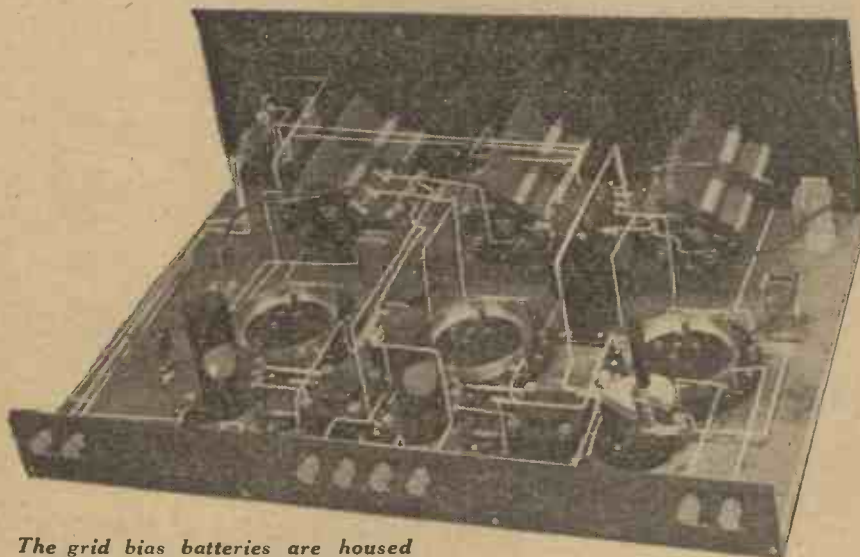

*The grid bias batteries are housed inside the cabinet, secured in special clips at each end of the baseboard.*

the signals will be considerably increased in volume. The tuning will be found to be practically the same as when using the receiver as 2 H.F. and a crystal, the only difference

gives a list of some 20 stations which were all received on the loud-speaker. The aerial employed for the tests was quite a simple 60-ft. aerial about 20 ft. high, so that conditions were

NEWS IN ADVERTISEMENTS

Messrs. Falk, Stadelmann & Co., Ltd., request readers to write for their catalogue, in which appear full descriptions of their products—including the Variform low-frequency transformers.

Readers are invited to send for illustrated leaflets dealing with the comprehensive range of Benjamin Products. It is interesting to note that this Company announce in their advertisement the marketing of the Benjamin Radio Valve.

The advertisement of the Varley Magnet Co. gives particulars of the new Varley Multi-Cellular high-frequency choke.

Messrs. Hart Accumulator Co., Ltd., request readers to write their department W.C.R. for full particulars of Hart batteries.

Messrs. Pettigrew & Merriman (1925), Ltd., advertise their willingness to send the Newey Catalogue of Radio Components to any reader.

An announcement of the "Brandset" receivers is made in this issue by the manufacturers of the well-known "Brandola" and "Table-Talker" loud-speakers.

No. J.105 is a very interesting pamphlet on the Igranic Super-heterodyne, which Messrs. Igranio Electric Co., Ltd., will send to readers on receipt of a postcard.

In their advertisement, Messrs Bowyer-Lowe Co., Ltd., give particulars of their Gang-control condenser, especially designed for the Elstree "Solodyne." Full particulars of this and other products of this Company can be obtained by writing for the latest number of the Bowyer-Lowe Radio News.

equal to those obtaining under average circumstances.

By placing the dials approximately in the positions shown, and swinging them one after the other one or two degrees on either side, the stations may be picked up with comparative ease. After practice has been acquired in this manner, the telephones may be inserted in jack No. 2 and the full capabilities of the receiver may then be judged. It will be found, as a matter of fact, that in many cases the stations can be tuned in direct on the loud-speaker when the settings have become known and a little experience in tuning has been acquired.

(Concluded on page 1118.)

# DEMONSTRATIONS OF RADIO PRESS STAR SETS

The New Elstree Developments Explained

## RADIO PRESS LECTURERS TO TOUR THE COUNTRY

WE are pleased to be able to announce to our readers that Radio Press, Limited, the proprietors of this journal, and also of *Modern Wireless* and *Wireless*, are proposing to arrange to tour the country and give lectures on and demonstrations of the new developments which have resulted from the research work in their Elstree Laboratories.

### Radio Press Designs

The Radio Press designers have in the past enjoyed a considerable reputation by reason of the receivers which they have produced; and Radio Press sets have been extremely popular in the past. In the catalogues issued by the principal firms catering for constructors, more than 90 per cent. of the designs are those published in Radio Press journals. Now every Radio Press designer realises how revolutionary are the new developments which have come from Elstree. It is therefore the intention of Radio Press, Limited, to endeavour to create a great revival of interest in radio by demonstrating the new receivers and showing how much superior they are to the older designs.

### The Elstree "Solodyne"

In the September issue of *Modern Wireless*, which was published on September 1, are given the details of a Radio Press Star set, the Elstree "Solodyne." With this remarkable receiver it is possible, by adjusting a single dial, to bring in numerous stations at full loud-speaker strength. This receiver is to be demonstrated by Radio Press, Limited, in different parts of the country.

It is obviously out of the question to make arrangements for every one of our readers to see and operate the "Solodyne," but wireless enthusiasts who attend the lectures and demonstrations will be able to spread the news of the success of the receiver and

shall communicate with them before the lecture is given.

### Reserved Accommodation

Details of the Lecture Tours will also be published in *Wireless*, although we advise readers to send us a card, as in that case accommodation will be specially reserved for them. It may occasionally be necessary to give the same lecture several times over in a big town.

The Secretaries of Radio Societies in or near big towns who are prepared to assist in the organisation of the lecture and demonstration locally are also asked to communicate with us.

This new move will, we feel, inspire the greatest confidence in those who read our journals, and will show that we are anxious

to do everything possible to encourage our readers to proceed at once with the construction of the Radio Press Star sets.



The Elstree "Solodyne," described in the September issue of "Modern Wireless," is one of the sets which it is proposed to demonstrate.

to encourage others to build it and see for themselves.

It will only be possible to visit the principal towns. The lectures will deal with the research work which is done at Elstree, and the "Solodyne" and possibly also other sets will be demonstrated.

### Dates of the Lectures

It is impossible to give the dates of the lectures in *THE WIRELESS CONSTRUCTOR*, since it is only a monthly publication. You are therefore requested to send a postcard addressed "Lecture Tour," Radio Press, Limited, Bush House, Strand, London, W.C.2, giving your name and address, and stating the maximum distance which you are prepared to go to hear the lecture.

When a lecture is arranged, the first people to be invited will be those whose cards we have received, and we

### THE "ELSTREFLEX"

By JOHN SCOTT-TAGGART,  
F.Inst.P., A.M.I.E.E.

The first details of this new Star Receiver, the latest development of the Elstree Laboratories, appear in the issue of "WIRELESS" dated September 18th.

NOW ON SALE. Price 2d.

A FREE GIFT WITH EVERY COPY

# THE TRUTH (?) ABOUT CONDENSERS

By ANNE N. NIAS

IT is time, I think, that a really authoritative article was written on the subject of condensers fixed and variable, and since no one else seems to be tackling the job, I suppose that I had better take it on myself. There are scores of makes of variable condenser on the market, each of which is a very great deal better than any other; this must be true because the makers always say so, and surely to goodness they ought to know what they are talking about.

### Those Mystic Signs

The symbol used by you, by me, and by others of the common herd for the variable condenser, when we make what we are pleased to call diagrams, is



Only the Very Great are permitted to employ the symbol



The difference between a



and a



is precisely the same as that which exists between a soldering iron and a soddering iron. Personally I employ a slight variation of the first symbol for many variable condensers, drawing it thus:



The reason is that if, when sitting at my table, I draw it like this:



the arrow points exactly in the direction of the dustbin.

There are three main classes of variable condenser: the straight-line-capacity, known professionally as SLC, the straight-line-wavelength (SLW), and the straight-line-frequency (SLF); there is also a fourth sub-class known as KLA, or kinky-line-anything.

### Theory and Practice

The principle of the straight-line-

capacity condenser will be readily understood from inspection of Fig. 1, which shows the calibration curve of one of these instruments. It will be observed that, barring accidents, such as will happen, a steady increase in



... birds' nests in the condenser ...

the capacity takes place as the knob is rotated in a clockwise direction by the supple wrist of the user. The almost infinitesimal deviations from the straight line, which will be found if the diagram is inspected closely, are due to slight defects in the contact between the spindle of the moving plates and the bush. These are often caused by the presence of birds' nests in a condenser that has been in use for some time; precautions should, therefore, be taken to exclude our little feathered friends from the cabinet of the wireless set. Even a new condenser, however, may show distinct signs of wonkiness, for many manufacturers have so concentrated on the SLW, SLC or SLF ideas that they have no time to think about SLS, or straight-line-spindle.

### Straight Curvature

Turning now to the straight-line-wavelength principle, I present to



... probably a pair of broken ear-drums ...

your notice Fig. 2, which shows exactly how condensers designed on these lines carry out their duty. It will be seen that from 0 to 30 degrees or thereabouts the straight line forms a graceful curve; but if we refer, as we frequently do in wireless, to straight lines as curves, then why, I ask you,

should we not call a curve a straight line once in a way? From this point progress is upwards on true Excel-sior lines until the 60-degree mark is reached, where a slipping knob gives us a breathing space for a spell. Then we have another slopilinear bit, followed—are we not talking about variable condensers?—by a fall and a rise (and probably a pair of broken ear-drums) due to touching plates. With the exception of the initial slight curve, however, all the lines are straight, so that the condenser has lived up to its name.

### For the Mathematician

A straight-line-frequency, or, as I prefer to call it, straight-line-fre-quently condenser, is exceedingly useful for those who like to spend their

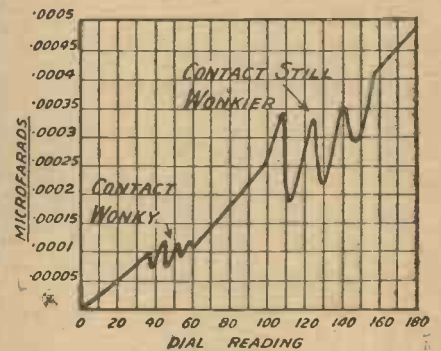

Fig. 1.—The curve of a straight-line-capacity condenser. Careful inspection of the bushes may lead to the discovery of the birds' nests which often cause the deviations shown.

evenings in working out the formula  $\lambda = \frac{300,000,000}{F}$  or conversely  $F = \frac{300,000,000}{\lambda}$ .

Actually this formula is not quite correct, since the speed of light is not exactly 300,000,000 metres a second; but this does not very greatly matter, since the answers produced by most enthusiasts would be incorrect in any case. I do not give a typical curve of the SLF condenser since I am not good at kilocycling, but it follows the same general lines as those seen in Fig. 1 and Fig. 2.

### Refinements

We come next to refinements in condenser design, such as the integral vernier and the slow-motion dial. Both of these devices were designed

# CLEARTRON



*The Master*

*of Space*

14/-

## STANDARD PRICES

18/6

America's foremost valve, made in Britain's newest factory.

*The valve exclusively used in the famous LODGE "N" circuit.*

Write for new season's catalogue.

## CLEARTRON RADIO LIMITED

ONE CHARING CROSS, LONDON, S.W.1 (Works: BIRMINGHAM)

Telephone: Regent 2231/2.

Telegrams: "Cleartron, Westrand, London."



C. T. 58

# The Truth (?) About Condensers—continued

to facilitate fine tuning, and they do so in a remarkably effective way. The word "vernier" is almost as blessed as Mesopotamia; like charity it covers a multitude of sins. Originally the word "vernier" was applied to delicate apparatus which enabled you to obtain a reading in tenths,



... without spoiling the temper of their families ...

hundredths or thousandths of a coarse main scale; in wireless it is used to describe a method which prevents you from obtaining any reading at all.

### Constant Entertainment

The variable condenser of the baser sort, with a still baser integral vernier, can be relied upon to ensure that the enthusiast has never a dull moment. It consists as a rule of a main spindle, carrying the moving plates, through which has been drilled a slightly eccentric hole. Through this passes a secondary spindle carrying a single plate which meshes with a lone fixed plate at the far end of the instrument. Since the vernier spindle does not like to be left out of it when the main spindle is moved, it travels to and fro whilst the coarse adjustments are made.

Fine work is accomplished by means of the knob attached to the vernier spindle. When this is moved it carries the main spindle with it, thus making it the easiest thing in the world to make a fine movement of fifteen or twenty degrees in either direction. Many a Londoner who has never previously heard Manchester has been able to pick up 2ZY through the help of the integral vernier condenser, the Northern station having been brought in by a sudden and fortuitous upward leap of its plates.

### More Entertainment

The slow-motion dial is designed somewhat on the lines of the gear-box on a motor-car. The idea is that since most of those who have made a hobby of wireless for any length of time are afflicted with Knob-Wangler's Twitch, it is impossible for them to make a small increase or decrease in their dial settings without some arrangement containing cogs, pinions, and other bits and pieces to help them. Some slow-motion dials are exceedingly useful for strengthening the wrists. If, for example, you choose one with a reduction of 300 to

1, you will have to give its knob about a hundred complete turns in a clockwise direction when you wish to ascend from London to Birmingham, and an equal number in an anticlockwise direction when you desire to reverse the process. Some of the handiest slow-motion dials are those which free-wheel for about ten degrees when you change the direction. These can be strongly recommended to confirmed knob twiddlers, who can sit happily waggling their dials of an evening without spoiling the temper of their families by constantly altering the tuning.

### A Fascinating Sport

Another most interesting type is that in which progress upwards or downwards is accomplished by means of a series of jumps; with these in use one's wireless evenings are simply packed with delightful surprises. You have got, let us say, Rome and you think of proceeding upwards to Toulouse. Placing your fingers upon the knob you essay to make a small clockwise movement. The knob appears to have stuck. You increase the pressure. It leaps forward and in comes Porsgrund, which you have never heard before and will probably never hear again.

Even more delightful is the little game of Catch-the-station which may be played, a game quite as exciting as Hunt-the-slipper or Catching-the-greased-pig. You are after, let us say, Dublin. You know that you are

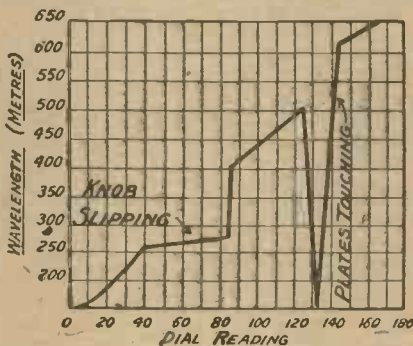

Fig. 2.—This chart illustrates the straight-line-wavelength principle as exhibited by a (very) variable condenser.

nearly there and every fibre is a-quiver. A tiny forward motion, a leap of the dial, during which you hear one wail from the Irish pipes, and you have gone too far. You turn back. Another jump, another wail. And so filled with growing excitement you repeat the process again and again, until there comes a sudden mighty jump which lands you bang in the middle of Frankfort.

### A Warning to Twiddlers

Should variable condensers have

ball bearings? This is a most important question to which every wireless enthusiast should pay the closest



... the instrument has burst into flames ...

attention. Personally I contend that for confirmed ether-rakers, ball-bearing spindles are absolutely essential, for I have known many cases in which the friction of plain bearings during a prolonged search for an elusive station has generated such heat that the instrument has burst into flames, doing serious damage to the receiving set and severely scorching the fingers of the operator.

If ball bearings are not employed, the condenser should certainly be provided with some means of keeping its bearings cool. It is an excellent tip to arrange a small tap immediately over the receiving set, so placed that a thin stream of water is directed upon the end bearing of the spindle. Immediately under the condenser is placed a neat tank to which is connected a pipe running to that portion of the geranium bed beneath which the earth plate is buried. Thus not only is the condenser kept cool but the earth is also automatically soaked, thus eliminating the damping due to resistance by means of the damping due to wetness.



### LOOK TO YOUR EARTHING SWITCH

MANY constructors show a partiality towards the type of aerial-earth switch which earths the aerial outside the house when the receiver is not in use. There is much to be said in favour of this principle, but the contacts which are exposed to the inclemency of the weather must be cleaned periodically, or some device made to cover them and prevent corrosion. The ingenuity of the constructor will not be taxed unduly in making a covering to fulfil this purpose.

Many of the switches one sees at the present time incorporate some form of patent lightning device, thus giving a measure of safety under all conditions.

H. J. B. C.





*A Notable & Popular Broadcaster's  
opinion of*

# 'HART' BATTERIES

**'MEET EVERY NEED  
OF EXACTING  
WIRELESS USERS'**

*says*

## J.H. Squire

OF THE CELEBRATED  
J.H. SQUIRE CELESTE OCTET



91, Templars Avenue,  
Golders Green,  
London, N.W.11  
Messrs. Hart Accumulator Co. Ltd.,  
Stratford, London, E.15.

Dear Sirs,

There is no doubt, in my opinion, that the "HART" High Tension Batteries and Low Tension Accumulators will meet every need of the most exacting "Wireless enthusiast" - whether for transmission or reception. The absence of noise in operation is only equalled by their strong construction and attractive appearance, whilst the additional guarantee for a full year makes me feel sure that all who try them will agree with me in testifying to their undeniable merits.

Yours very truly,

*J.H. Squire*  
THE J. H. SQUIRE CELESTE OCTET.

June 22nd, 1926.

# HART

**THE BATTERY OF QUALITY**

There are models of "HART" BATTERIES for all wireless circuits. Write to-day to Department "W.C.R." for illustrated leaflets and full particulars.

**HART ACCUMULATOR CO.LTD. STRATFORD LONDON E.15**



*The*  
*Best in the World*  
**HELLESEN**  
**DRY BATTERIES**

They give you the best in radio reception, and what is far more important, they give it for the longest period.

To-day, when radio is only a matter of switching on, and a pleasure free to every member of the family, a H.T. Battery which possesses the power of recuperation is absolutely necessary.

Recuperation means increased pleasure, less expense, and the new No. 7 Recuperating Agent in the Helleesen Battery is the result of 40 years' striving to this end.

You now have the opportunity of buying at a **COMPETITIVE PRICE**, Batteries which have always held the leading position on quality, not on price.

With quadruple insulation and sealed cover the genuine Helleesen is the **GENUINE ARTICLE**.

60 volt "WIRIN," 12/6. 99 volt "WIRUP," 21/- (Postage extra).

All types, voltages, etc., in Double and Treble Capacities. Dry Batteries for Low Tension, Hand and Pocket Lamps.

From all Radio, Electrical and General Stores, Harrods, Selfridge's, Barker's, Whiteley's, etc., or direct from—

**A. H. HUNT, LTD.** (Dept. 15), **CROYDON, SURREY.**

Write for leaflet No. 155a.

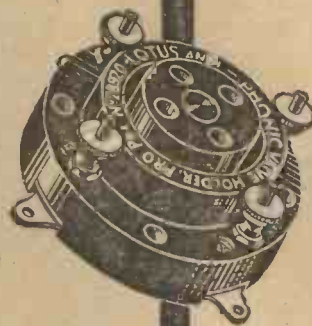

It will  
Pay You  
to see this  
Exhibit!

Visit Stand No. 84 at the National Radio Exhibition—see the "Lotus" Valve Holders and learn just how and why they excel in absorbing shock, protecting the valves and eliminating all microphonic noises.

Rigorous tests at the factory ensure that "Lotus" Valve Holders will give entire satisfaction under any conditions. That is why you should insist on them for *your* set.

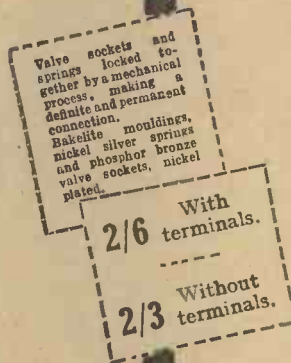

**LOTUS**

BUOYANCY

**VALVE HOLDER**

ANTI-MICROPHONIC

Made by the makers of the famous Lotus Vernier Coil Holder,  
**GARNETT WHITELEY & CO., LTD.,**  
Lotus Works, Broadgreen Road, LIVERPOOL.



# TALKS TO BEGINNERS

By PERCY W. HARRIS, M.I.R.E.

## VII.—DEVELOPMENTS IN RANGE AND SELECTIVITY.

THE reader who has carefully read through my previous articles will by now be able to look at a wireless receiver, whether factory built or home constructed, with a greater interest than formerly. He will be able to take in at a glance the general features of a set, and will be able to some extent to appraise its value, and if, as is probably the case, he has been working a receiver for some time, he will be in a better position to appreciate features which make his set distinctive and to judge for himself whether or not it is really up to date.

This leads me to give this month a short talk on some of the more recent developments in sensitivity and selectivity, and to try and show how the ideal in these matters is not easily achieved, since both man and nature place certain difficulties in our way.

### "Range" of a Crystal Set

Let us deal first of all with sensitivity. If you erect a simple aerial and crystal set connected to an efficient circuit you will be able to hear your local broadcasting station, a few Morse stations and ships, and very little else. The reason is, as explained previously, that you have to deal with the energy received at your aerial without amplification. By adding amplifiers to your crystal set you will greatly increase the volume of sound given out, and, indeed, the sounds from the local broadcasting station can easily be made so overwhelming as to be a nuisance to yourself and your neighbours, but you will probably listen in vain for the slightest sound from more distant stations, which somehow or other remain beyond your reach. Although low-frequency or "note" magnifiers do add to some extent to the range of a set, in order that distant stations may be brought in well, or even at all in some cases, it is necessary to introduce high-frequency magnification or magnification of the minute radio-frequency currents before they are passed to the detector.

### High-Frequency Stages

In such a modern receiver as the Night Hawk, efficient high-frequency amplification is provided before the detector stage, and after this, further

efficient magnification is used to bring up the volume. Those of us who have been connected with radio from its early days know that in a very large number of cases the home constructor who has successfully built a crystal or a single-valve set embarks lightly-heartedly upon the construction—often to his own design!—of an elaborate multi-valve set, expecting to get miraculous results without the slightest difficulty.

### There's Many a Slip . . .

"Surely," he says to himself, "if each valve gives a certain amount of magnification, all I have to do is to make a set with as many valves as I can afford, and I shall bring in America without the slightest difficulty. After all," he continues, "I can easily work out the circuit. I shall connect my tuner to the first high-frequency valve, transformer couple this to the next, and so on for four or five stages. Connect it to the detector (I have one already made),

then—well, we had better draw a veil over the conclusion of the story!

### Is H.F. Efficient?

Two or three years ago a large number of experienced amateurs held the view that it was impossible to get any real magnification by high-frequency stages, and challenges were bandied about by owners of single-valve and reaction sets, who claimed that by critically adjusting reaction they were able to get as strong signals as their rivals were obtaining with two stages of high-frequency preceding their detector. Strange as it may seem to the beginner, they were often able to prove their case, and I have been present at more than one demonstration where the owner of a multi-valve set has had to retire much humbled from a contest with another amateur with only a detector followed by a couple of stages of note magnification.

### The Cause of the Trouble

Framed in a few words, the reasons were as follows:—The grid circuit of



\* \* \*

*The remarkable performance of the famous "Elstree Six" is largely due to the use of very efficient high-frequency transformers.*

\* \* \*

and then add three or four stages of low-frequency. I am sure no one in my neighbourhood will have such a wonderful set!"

More than likely he will take a popular design such as the "Elstree Six," modify it to suit the cabinet he has, remove all kinds of arrangements which appear to him unnecessary, and

the first high-frequency valve was tuned in the conventional way and the anode circuit was joined to a transformer, in which the primary and secondary were very tightly coupled. Either the primary or the secondary (it did not greatly matter which) was tuned, and as soon as the grid circuit

## Talks to Beginners—continued

and the anode circuit were brought into tune, the stray fields from the coils and the tiny condenser formed between the grid and the anode itself of the valve were together sufficient to hand back more than enough energy to maintain a continuous state of oscillation.

### Stability—at a Price

To check this oscillation, all kinds of devices were tried, the most effective being to connect the wire, which normally would go from the condenser to the filament of the valve, to the slider of the potentiometer, by varying which it was possible to impress upon the grid of the valve a varying degree of positive potential. By adjusting this potentiometer slider a point was reached when oscillation just ceased, and the set was then stable. It was not generally realised that this stability was obtained by introducing losses into the circuit equivalent to introducing high resistance; thus stability was gained by sacrificing efficiency.

### Some Good Results

Now if the parts were carefully chosen and carefully arranged so as to give a minimum of interaction between transformers and coils and also between wiring—for interaction between wiring is an important

matter in wireless receivers—it was possible to obtain a fair degree of amplification, even after the losses had been introduced. I did a good deal of work myself in this direction, and succeeded in bringing out several sets having very distinct amplification for each stage, and a number of these sets, known as the "Transatlantic" series, have remained popular to the present day.

### Careful Design Needed

Before these designs were produced, however, all kinds of difficulties had to be overcome, for it was quite a simple matter to make a set which was quite stable, but in which the losses in order to make it stable were so great as to cut out all amplification obtained by the valve. Thus, as in the cases above mentioned, it was possible to have a couple of stages of high-frequency magnification doing nothing more than hand on the signals un-amplified.

### The Neutrodyne System

About this time Mr. Scott-Taggart in England and Professor Hazeltine in America were working on the problem of obtaining stability in high-frequency stages without sacrificing efficiency. Ultimately they were able to produce a system known

as the "Neutrodyne" method which, instead of "killing" the oscillation by resistance and therefore by losses, brought it about that the tendency to feed back energy through the valve itself, by means of the small capacity between the filament and the anode, was balanced by an equal and opposite effect produced by certain coils and condensers. The energy which otherwise would have been wasted in heating the resistance was thus retained for use, thus increasing enormously the efficiency of high-frequency magnification.

### An Early Neutrodyne Receiver

I have indicated above that when the anode circuit and the grid circuit were brought into resonance with one another a certain amount of loss had to be introduced by the old method in order to obtain stability. With every additional stage of high-frequency magnification the "feed-back" increased, so that it was found impracticable to get any efficient amplification by means of the older method after two stages had been used. With the Neutrodyne method, however, it was possible to proceed still further, and in a very early number of THE WIRELESS CONSTRUCTOR (January, 1925) (Concluded on page 1100.)



### BACKLASH—

*That free-play inevitable in ordinary, geared Coil Holders and its consequent incorrect tuning and fading is*

### DEFINITELY BANISHED—The First Step to Perfection.

THE ECCENTRIC METAL BEARING, immediately adjustable for taking up wear (if any).

THE METAL TO METAL HELICAL GEARS (ratio 9 to 1) give a slow and even movement.

A SPECIAL LOCKING DEVICE gives a fixed security. These points together with a Finish consistent with the highest grade of workmanship throughout make

### THE PENTON TYPE "A"

### THE ONLY PERFECT COIL HOLDER

From your Local Dealer or Post Free. PRICE .. 6/-

MOVING BLOCK CANNOT FALL.

Inspect the Coil Holder at our STAND No. 5 OLYMPIA.



Patent No. 193150.

For Outside Panel or Inside Baseboard Mounting.

THE PENTON ENGINEERING COMPANY  
15, Cromer Street, Gray's Inn Road, W.C.1



## STEEL PLATE ACCUMULATORS FOR HIGH TENSION

Only 1/- per volt.

Absolutely Noiseless.  
No Acid. No Fumes.  
Last a Lifetime.

BATTERIES, LTD., REDDITCH  
LONDON SHOWROOMS:—220, Shaftesbury Avenue, W.C.2.



**TELSEN**  
L.F. TRANSFORMERS  
*Radio's Choice*  
British Made.

The L.F. TRANSFORMERS that give maximum volume without distortion.

Other types—  
Standard Open - - - 14/-  
TELSEN "ACE" - - - 9/6  
All models in ratios 5-1, 3-1, and Guaranteed for 12 months.

Shrouded Popular

**15/6**

TELSEN ELECTRIC CO.,  
207, Aston Road, Birmingham.

RANGE  
 VOLUME  
 SENSITIVITY  
 SELECTIVITY  
 STABILITY  
 PURITY

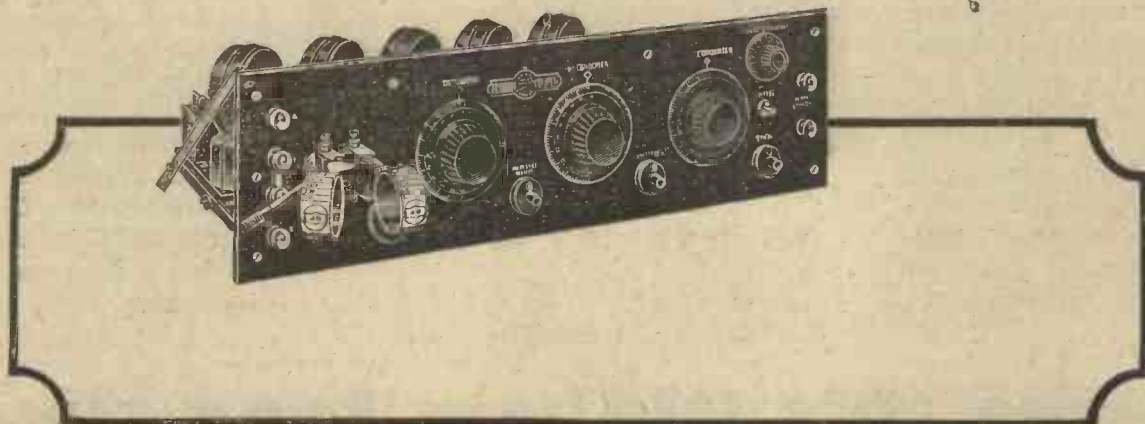
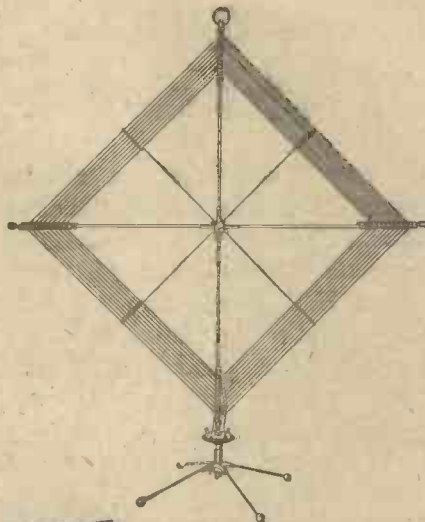

The many experts and amateurs who are using receivers built from the Igranic six-valve Supersonic Heterodyne Outfit, are all enthusiastic about the wonderful results obtained. Using the Igranic Frame Aerial, station after station can be tuned in with the greatest ease at full volume on the loud speaker. Usually all tuning is performed on two dials only. Users of these receivers are constantly writing to us telling of the remarkable range, sensitivity and selectivity they experience, with complete stability, full volume and purity of reproduction which satisfies the most fastidious.

May we send you List No. J105 containing full particulars ?

The Igranic Instructional Carton contains a fully illustrated handbook, full size working drawings, wiring diagram and drilling template for constructing a six-valve Supersonic Heterodyne Receiver according to the Igranic Design.

Price 2/6



Have you had your copy of the new Igranic Radio Accessories Catalogue ? If not, send us a postcard now, bearing your name and address, and the number J105.

149, Queen Victoria St., LONDON.

Works : BEDFORD.

# An adequate H. T. supply is more vital than you may think —

NO one would expect a railway engine handicapped by a leaky boiler to keep to its scheduled time table. You ought not to expect perfect results from any Set using a partly run-down H.T. Dry Battery. A falling off in sensitivity and a degradation in tone is inevitable. A good reserve of electricity is just as vital as a good head of steam. Many of the pitfalls in wireless are directly traceable to faulty H.T. supply. Everyone knows the noises and cracklings due to weak cells, but many of the troubles are much more subtle and not so easily traced. Such defects as a mysterious loss of 'pep' and failure to pick up distant

stations—distortion—lack of volume—and so on are frequently due to a faulty H.T. battery. An H.T. dry battery starts working the day it is made—it can't be controlled. If it has been on the Dealer's shelf for a month or two before you get it then naturally you cannot expect a full voltage. Even a voltmeter isn't a safe guide because an idle H.T. Battery will always produce enough current to flick over the needle. It is on the long sustained discharge where it fails so miserably. And here is where the new Oldham H.T. Accumulator comes into its own. Use it for hours on end and the current flow won't vary a trifle.



**60 Volts 50/- as above**  
 Complete with lid and 3 handles. Base 3/6 extra if required  
 40 volts £1 - 13 - 4      100 volts £4 - 3 - 4  
 80 volts £3 - 6 - 8      120 volts £5 - 0 - 0  
*A tapping point is available on each 2-volt cell.*

## Charge this Oldham four times a year—and forget it!

LOOK at the cleverly designed Oldham H.T. Accumulator shown above. Note that it is assembled on the unit system. Each unit consists of 20 volts: Build them up just like an expanding bookcase. 60, 80, 120 volts—just what you will. The Accumulator is always neat and tidy—fit to take its place in any

room. Acid can't be spilt and when it needs re-charging a convenient carrying handle is available. Each of its big capacity cells is a miniature Oldham accumulator capable of holding its charge for months on end. Each plate is made under the same Special Activation Process which has made the name Old-

ham famous throughout the country. Ask your Dealer to show you one of these handsome H.T. Accumulators—don't be put off with a substitute. Nothing can take its place for none other can give you the same steady flow of power—the same freedom from sulphation and the same generous length of service.

**Oldham & Son Ltd., Denton, Manchester**

London Office—Hazlitt House,  
 Southampton Buildings, W.C.2

Service Depot—6, Eccleston Place,  
 Phone: Vict. 0286 S.W.1



# Accumulators

Gilbert Ad. 565t

# THE "RECRUIT'S" SINGLE-VALVE RECEIVER

By GEORGE T. KELSEY.



*An easily constructed and inexpensive receiver, which may be relied upon to give good results in the hands of a "recruit" to radio. Varying degrees of selectivity may be obtained to suit individual requirements.*

THIS period of the year can usually be regarded as the time when a large number of people become interested for the first time in radio. The reason for this probably lies in the fact that the dark evenings which are most suitable for the reception of wireless signals are those upon which tennis and similar outdoor pastimes cannot be followed. The construction of wireless receivers temporarily fills the time during the winter months.

The requirements of a recruit to radio whose intention it is to construct a valve receiver, usually amount to simplicity of operation and a low initial outlay, and, bearing these two points in mind, there is much to be said in favour of a receiver employing only one valve.

set, in which case the running expenses will be very low.

### What You Will Need

In another part of this article the components used in the original receiver are listed together with the makers' names or trade marks. From this it should not be imagined that these are the only suitable makes, and reference to advertised goods elsewhere in this issue will reveal many of different manufacture. If substitutions are made, however, it is important that they should be capable of adaptation to the particular layout of the set.

### The Coil Holder

The inaccessibility of the coil holder when it is mounted inside the cabinet, owing to the wiring and neighbouring components, led the writer to mount it in the position shown on the side of the case. This has the additional advantages that a much smaller cabinet can be used, and that by having the coils mounted externally an "X" coil can be used, the aerial lead being connected direct to one of the two terminals on the coil.

on your own panel. Of course, the substitution of different components for those recommended may call for slight modifications when laying out the panel, but care should be taken to see that any alterations made are only slight.

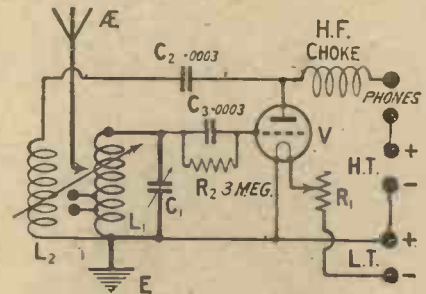

Fig. 1.—The aerial may be tapped on at any one of three points to obtain the required degree of selectivity.

### Fixing the Panel

It was not found necessary to employ brackets to support the panel, so that when this latter has been drilled it may be attached to the baseboard by means of three 3/4-in. wood screws. The terminals are best mounted in position before the variable condenser and the rheostat. Eight terminals in all are required—one for aerial and one for earth, two for the H.T. and two for the L.T. battery, the remaining two being those to which telephones are connected. When mounting the variable condenser the metal shield should be connected to the earth terminal.

### Baseboard Components

The valve-holder, H.F. choke, clip-in condenser, and the grid-leak and condenser are mounted on the baseboard. The wiring diagram will show how the available space is utilised, and the reader is recommended to adhere to this arrangement. Incidentally, employment of the particular layout of components shown in the original set will simplify the wiring to a considerable extent.

To the left-hand side of the cabinet the two-coil holder should be secured in such a position that the knob of the control handle comes in the same plane as the knobs upon the panel. Three holes should be drilled in the

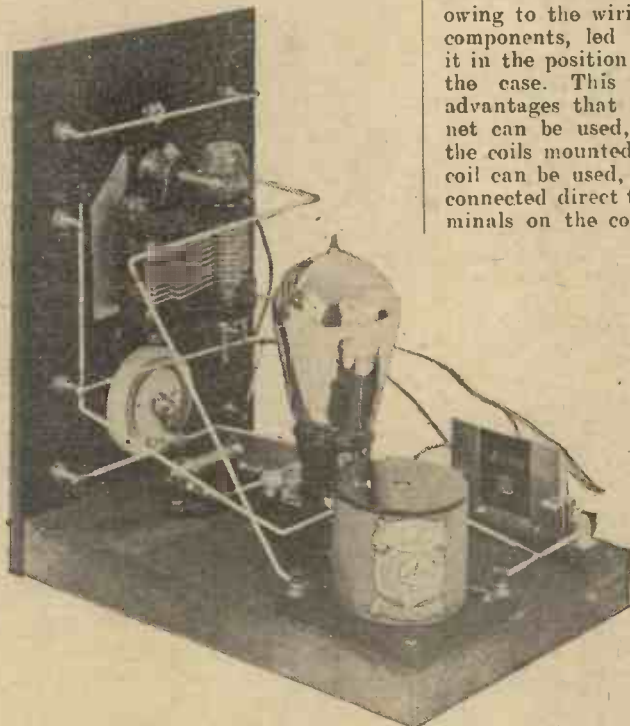

### A Practical Design

A receiver which has been designed to meet the needs of the beginner and which calls for the use of only one valve may be seen in the photographs accompanying this article. A dull-emitter valve may be employed in the



*The wiring should be carefully arranged to allow of free vibration of the valve in its holder.*



Although an aerial terminal is provided on the panel, this is only for use when it is desired to use direct aerial coupling.

### Concerning Construction

The drilling layout is shown in Fig. 2, and this can be followed out

# The "Recruit's" Single-Valve Receiver—continued

side of the cabinet, one above and two below the coil holder, to pass the leads through to the inside.

a glow is visible. Leaving the resistance on, transfer the L.T. battery to the terminals on the panel marked

coil should be a No. 50 or 60, and for reaction the smallest coil possible to obtain a reaction effect should be used. When using direct aerial coupling it

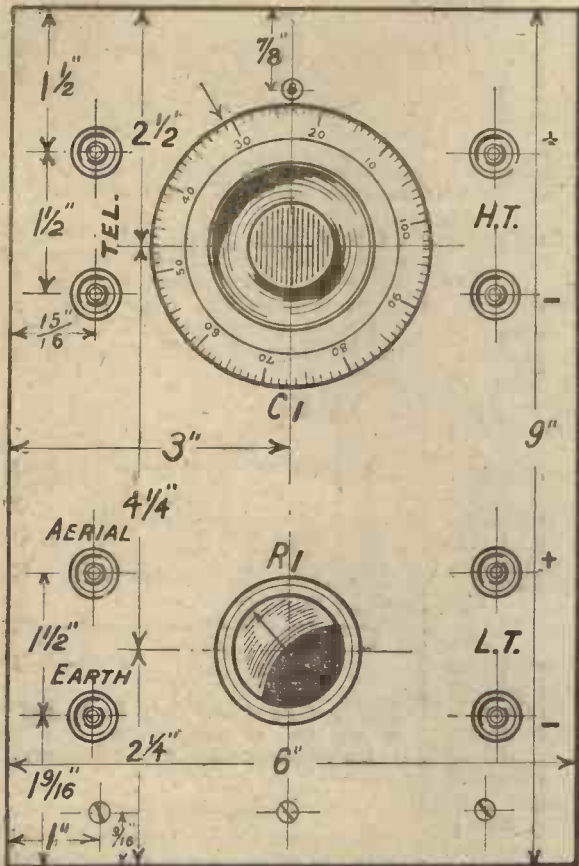

Fig. 2.—This diagram will provide drilling dimensions for the panel. Also obtainable as a blueprint, No. C.1064A.

### BUILD THIS SET WITH

- One cabinet to take panel 9 in. by 6 in. and baseboard 8 1/2 in. deep (Carrington Manufacturing Co., Ltd.).
  - One Becol panel 9 in. by 6 in. by 1/4 in. (British Ebonite Co., Ltd.).
  - One "Colvern" selector low loss condenser .0003 (Collinson Precision Screw Co., Ltd.).
  - One "Competa" arrow line rheostat, 35 ohms (A. F. Bulgin & Co.).
  - One H.F. choke (Beard & Fitch, Ltd.).
  - One Benjamin non-microphonic valve-holder (Benjamin Electric, Ltd.).
  - One clip-in condenser .0003 with baseboard mount (L. McMichael, Ltd.).
  - One grid condenser and leak .0003 and 3 megs. respectively (Dubilier Condenser Co., Ltd.).
  - One two-way coil-holder (Penton).
  - Eight type W.O. terminals.
  - Glazite and flex for wiring and a quantity of wood screws.
  - Radio Press panel transfers.
- Approximate cost, £4.

is likely that a No. 35 or 40 coil will be large enough for  $L_1$  wavelengths up to about 400 metres. The telephones and earth are the only other external

### Simple Wiring

In view of the printed wiring instructions and the back of panel drawing shown in Fig. 3, further detailed explanations of the procedure to be adopted in wiring are deemed unnecessary; regarding the connections to the coil holder, however, a few words may be helpful. These are carried out with flex wire. The aerial and earth terminals should be connected to the two screws on the fixed coil block connecting the earth to the pin side. The flex leads for these two connections pass through the two lower holes in the cabinet. A flex extension of the wire to the earth side of the aerial (fixed) coil mount should be secured to one side of the moving socket, the remaining connection on this latter being connected to one side of the condenser C2. After the application of suitable panel transfers, the receiver is ready for testing.

### Filament Wiring

Connect up the L.T. battery to the appropriate terminals and insert a valve in the holder. Slowly turn on the filament resistance and notice if the valve gradually lights up. This is, of course, assuming it to be a valve from which

H.T., when no degree of illumination whatever should be visible from the valve. Should the filament light up under these conditions turn off the rheostat and carefully check the wiring until the error is found. For the test just described, the coils should be mounted in the holder.



Here the fixed condenser C2 has been removed from its clips to show clearly the wiring to the valve holder.



With the filament wiring in order, connect up the batteries, using between 30 and 45 volts high tension. Place an "X" coil in the fixed coil socket and connect the aerial lead to one of the terminals on its side. The aerial

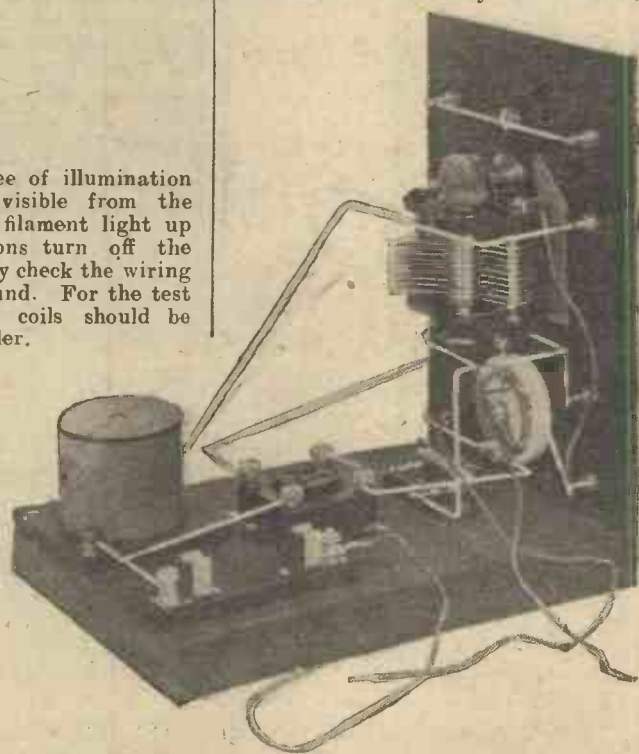

connections to be made before the tests on broadcasting are made.

### How to Test

Place the two coils at right angles and turn on the filament resistance.



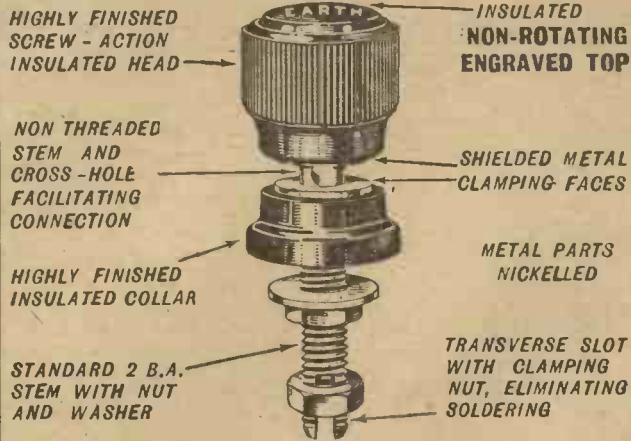

PATENT

Beautifully finished genuine bakelite and engraved with 28 different letterings.

STANDARD MODEL, 9d. each. POPULAR METAL MODEL, 6d. each

DIAL INDICATORS, 6d. each.



One-hole fixing, 8 different letterings.

Solid cast metal with white polished letters on a black background.

# BELLING-LEE

## PANEL FITTINGS

Advertisement of Belling & Lee Ltd.

Queensway Works, Ponders End, Middlesex

### ? CHOKE COUPLING ?



## AUDIO FREQUENCY TRANSFORMERS TYPE AF3

GIVE ALL THE ADVANTAGES CLAIMED FOR CHOKE COUPLING

PLUS

A STEP-UP OF 3½ TO 1

25/-



Ask your Dealer for Leaflet W-401. Send us the diagram of your set, and refer to this advertisement and we will suggest improvements.

FERRANTI LTD., Hollinwood, Lancashire.

APPOSITE ADAGES, No. 5.

Don't Spoil the Ship

Specify

DUBILIER PRODUCTS



Have you entered for the Dubilicon Competition yet?

If not, write to us now for full particulars.

Cash Prize £200.



ADVT. OF THE DUBILIER CONDENSER CO. (1925) LTD., DUGON WORKS, VICTORIA ROAD, N. ACTON, LONDON, W.3. Tel. Chiswick 2241-2-3.

E.P.S. 217

# The World's Standard

STANDARD  
**DRAGON  
AMPLION**

*Wireless  
Loud Speaker*

Type A.R. 19



*Write for the  
latest Illustrated  
Price List*

Price £5 : 5 : 0  
Obtainable from all Radio  
Dealers or Stores. Other  
AMPLION MODELS from 38/-



## There is no substitute for a genuine AMPLION

Announcement of ALFRED GRAHAM & CO. (M. Graham), 25, Savile Row, London, W.1.

In replying to advertisers, please mention THE WIRELESS CONSTRUCTOR.

# The "Recruit's" Single-Valve Receiver—*continued*

Tune with C, until signals are heard from the local station. The reaction coil may now be brought slowly towards the aerial coil, when the strength of

signals should increase. Be very careful at this stage, however, for at a certain position a slight "rushing" sound will be heard in the telephones,

and on no account should the reaction coil be taken past this position, otherwise you will be liable to cause your neighbours considerable interference.

### Smooth Reaction Control

For the reception of distant stations it is essential that the reaction control be very smooth, and if the set

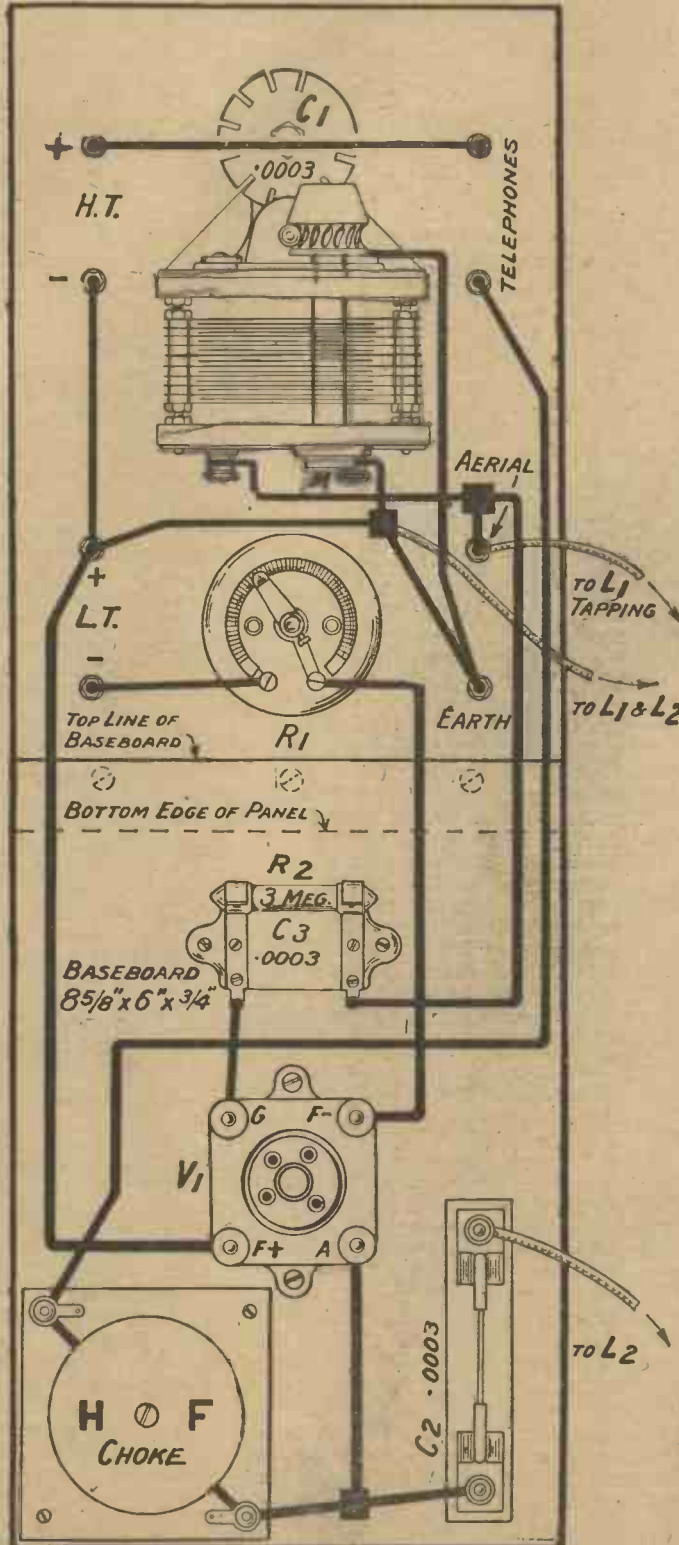

Fig. 3.—The flex leads are attached to the coil holder after the set has been placed in the cabinet. Blueprint No. C.1064B.

### WIRING IN WORDS

Join AERIAL terminal to fixed vanes of variable condenser C1, also to one side of fixed condenser C3, and attach a flexible lead to the terminal.

Join EARTH terminal to moving vanes of variable condenser C1, also to L.T. positive terminal. Also attach a flexible lead to the EARTH terminal.

Join L.T. positive terminal to H.T. negative terminal and to one filament contact on valve holder.

Join L.T. negative terminal to one terminal of the filament rheostat R1.

Join other terminal of R1 to remaining filament contact on valve holder.

Join remaining side of fixed condenser C3 to grid contact on valve holder.

Join H.T. positive terminal to the upper TELEPHONE terminal.

Join the lower TELEPHONE terminal to one side of H.F. CHOKE.

Join other side of H.F. CHOKE to anode contact on valve holder, also to one side of fixed condenser C2.

Attach a flexible lead to other side of fixed condenser, C2.

After inserting the set in the cabinet, join up the flexible leads to the coil holder as follows:—

Join leads from AERIAL and EARTH terminals to fixed coil block, the lead from EARTH going to the pin.

Join this pin also to socket of moving coil block.

Join lead from fixed condenser C2 to pin of moving coil block.

tends to start oscillating suddenly with an audible "plop" in the telephones try adjusting the values of high- and low-tensions.

After a short experience of handling the instrument the reception of distant stations under favourable conditions will become moderately easy. For such reception the receiver should be worked in its most sensitive condition, which is just below the oscillation point.

Just one further note regarding reaction. Should an increase in coupling between the two coils bring about no increase in signal strength then try reversing the leads to the moving coil block.

### Author's Results

The original instrument has been well tried out in a locality about ten miles west of the London station. Bournemouth, Birmingham, Manchester, and, on one occasion late at night, Belfast, are among the British stations which have been received. Many Continentals, including Toulouse, Oslo and Hanover, have also been heard. The above results were obtained in darkness and under fair conditions, although there is little doubt that anyone under favourable conditions and capable of handling the receiver correctly could repeat the performance.



# Notes & Tottings

A Page of Information of Interest to All Constructors.

**I**N spite of the large number of different types of coils which are now available ready made for the constructor, there must still be many who prefer to make as much as possible of their receivers with their own hands, and who therefore like to wind their own tuning and other coils. The winding of solenoid coils is quite straightforward until it comes to the making of tappings. The most commonly adopted procedure in making tappings on such coils is to twist the wire up into small loops at the tapping points and subsequently to strip the insulation from these loops and solder leads to them.

This method does not prove very satisfactory if the finished coil is to be handled much in trying it in various circuits. The loops are liable to untwist slightly, with the result that the winding becomes loose on the former; this tendency may be reduced by varnishing the winding, though even by this expedient not altogether eliminated. A method of taking tappings which will stand any amount of handling without damage is illustrated in Fig. 1. The wire is wound on until the required point is reached, when a

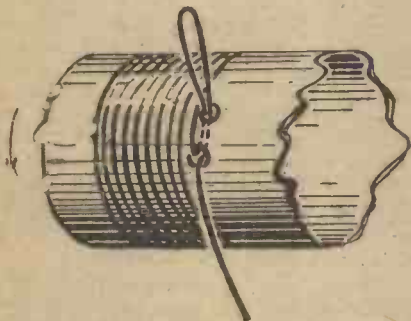
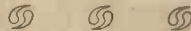

Fig. 1.—The holes in the former through which the loop is passed should in practice be as small as possible.

small hole is made in the former close up to the last turn. A loop of the wire about 2 in. long is passed through this, and then back again to the outside of the former through another hole, also close up to the last turn of wire and about  $\frac{1}{4}$  in. from the first hole in the reverse direction to the winding. A

touch of shellac varnish on the two holes will make a thoroughly secure job of the tapping.



**T**HE value of graphite as a lubricant is often overlooked, although, of course, it forms the base of a number of light lubricating oils, such, for example, as are used for the moving parts of small machinery. It sometimes happens that the bearings of a variable condenser become harsh, and if they are allowed to continue in constant use without attention, small particles of metal are likely to be rubbed from the bearings or the spindle, causing most annoying grating noises when the condenser is operated.

The application of oil or vaseline to the bearings is not a very satisfactory cure, as these substances tend to collect dust and so to produce a similar trouble in another way. A better method of applying the necessary lubrication is to dismantle the spindle from its bearings and to rub both spindle and bearings thoroughly with an ordinary drawing pencil, of HB or B grade. If it is not desired to take the condenser to pieces, a very little finely-powdered pencil "lead" may be introduced into the bearings from the outside, after which the spindle should be turned backwards and forwards to work in the lubricant.



**T**HOSE who are sufficiently careful of their accumulators to check their condition periodically with a voltmeter sometimes fail to realise the fact that the accumulator should be checked only when it is "on load," that is to say, when current is being drawn from it. When an accumulator has been left standing for some hours it will often show a full reading on the voltmeter, even though it is discharged so far that it will not supply enough current to run the valves in the receiver. The voltmeter itself, if it is of a good make with a resistance high enough to prevent it passing more than a few milliamperes, will not impose sufficient load on the cells to cause any appreciable drop in voltage.

Actually the voltmeter should be applied to the cells when they are connected to the receiver with the valves alight. A more correct indication of their condition will then be obtained. To ascertain the actual voltage applied to any particular valve the voltmeter may be connected temporarily to the filament contacts of the required valve holder, the valve being left in position.

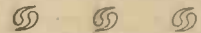

**M**OST constructors of home-made apparatus have probably at one time or another endeavoured to build a variable condenser, either from purchased parts or from the raw material in an unfinished state. Those who have made the attempt will no doubt have discovered that the job is by no means an easy one, unless an adequate tool kit is available. The small neutralising condensers which are in such common use nowadays with the advent of really satisfactory neutralised high-frequency amplification, are no exception to the rule, especially as they must be capable of accurate adjustment if the receiver is to function properly.

A substitute for this type of condenser can be readily made up in the home-constructed receiver. The method of providing the necessary



Fig. 2.—The ends of the leads which are to be tied together should be well straightened before being secured.

neutralising capacity is illustrated in Fig. 2. The ends of the two leads which would be taken to the terminals of the condenser are tied together side by side, and the amount of overlap is adjusted until the correct neutralising effect is obtained. Care must be taken that the two wires are well insulated, as otherwise a short circuit of the high-tension battery may result. If the existing insulation of the leads is distrusted, a short piece of insulating sleeving may be slipped over their ends before they are adjusted and fixed in position.

# Here are the N.P.L. figures —now you can judge for yourself!

TABLE 1			TABLE 2			
Coil	Inductance in microhenries	Self-capacity in micro-microfarads	Coil	Parallel capacity in micro-microfarads	Wave-lengths in metres	Effective resistance in ohms
35	61	15	35	300	264	2.8
40	90	15	40	"	318	2.9
50	150	9	50	"	406	3.3
60	200	13	60	"	472	4.4
75	295	12	75	"	573	5.3
100	540	11	100	"	774	6.6
150	1,410	12	150	"	1,250	15.8
200	2,220	17	200	"	1,580	19.7
250	3,070	17	250	"	1,860	24.9
300	4,800	14	300	"	2,320	28.2

**I**N the design of radio inductances it is a well-established fact that the smaller the R/L value for any circuit the greater is the selectivity and signal strength.

Because this fact predominated in the design of the LEWCOS Coil we can publish without fear the R/L values obtained in independent tests by the National Physical Laboratory.

### Why the wave-length is given.

We would draw the attention of readers to the wave-length at which the measurements were made. This is a most important point which is often overlooked by amateurs and sometimes even by manufacturers when



quoting the H.F. resistance figures for their coils. Resistance in high frequency varies with the frequency and to give a figure for H.F. resistance without the wave-length at which that resistance was measured is valueless.

### Try this better coil yourself!

You will be delighted at the improvement in reception when you use Lewcos Coils. Besides being highly efficient they are strongly constructed and of good appearance. Try Lewcos Coils in your set—they make all the difference!

Your wireless dealer stocks or can obtain Lewcos Coils for you. Write for descriptive leaflet.

## LEWCOS Inductance Coil

No.	25	35	40	50	60	75	100	150	200	250	300
Price	4/6	4/6	4/6	5/-	5/6	5/6	5/9	7/6	8/6	9/-	10/-

THE LONDON ELECTRIC WIRE COMPANY & SMITHS, LTD.  
Playhouse Yard, Golden Lane, London, E.C.1

Phone : Clerkenwell 1388]

[Telegrams : Electric, London

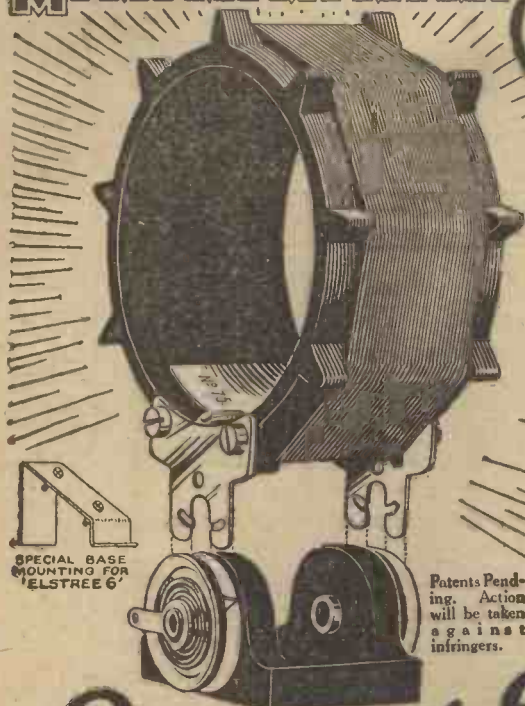

Patents Pending. Action will be taken against infringers.



# Rout your Enemy — H·F RESISTANCE!

High-Frequency Resistance, the dreaded enemy which crept into your Receiver during its construction, rendering it unselective, and generally defeating your efforts to tune in distant broadcasting, can now be easily circumvented.

There is no secret—one glance at the



## UNIMIC COIL

will tell you all.

It is robust in construction, yet is by far the most efficient coil of its type. The base is of special interest. As will be seen from the illustration the connecting plates on the coil are firmly gripped between the spring connecting jaws on base, ensuring a tight contact, at the same time enabling the coil to be moved through an angle of 90°.

For those who have constructed, or propose constructing the "Elstree Six," the **MH** UNIMIC COIL is particularly interesting. It takes the place of the ordinary duo-lateral coil advantageously, since it gives a tighter coupling between the primary coil and tuned secondary, resulting in a very definite increase in signal strength. In this connection a special mounting for base will be supplied when the **MH** UNIMIC COIL is to be used in the "Elstree Six." Price 5/-. Base 2/6 extra.

Demand of your dealer **MH** Components.

BRITISH, BEST, and CHEAPEST in the Long Run

### L. M<sup>c</sup> MICHAEL LTD

Manufacturers of Wireless and Scientific Apparatus  
WEXHAM ROAD, SLOUGH, BUCKS.

Telephone:  
SLOUGH  
441-442

Telegrams:  
Radiether,  
Slough.

### NEW **MH** COMPONENTS OF EXTREME INTEREST

**MH** Dimic Coil. No. 1.  
Taken at the Middle frequency it has a resistance of 5.25 ohms at a frequency corresponding to 400 m., i.e. .026 ohms per  $\mu$ H.  
Price 10/-. Base 2/6 extra.

**MH** Balancing Condenser.  
The growing need for precise balancing encouraged us to produce a component which you will find essential.  
Price 1/9.

**MH** Supersonic Block Unit.  
Is the essential part of a Supersonic Heterodyne Receiver.  
With a few additions that you already possess you will have a Super-Het. Receiver ready for reception in half-an-hour.  
Price £6 6 0.

Exhibiting at **OLYMPIA**  
September 4th to 18th  
STAND No. 142





*The New Hall at Olympia, where the National Radio Exhibition is being held.*

## Have You Been to Olympia Yet?

# THE NATIONAL RADIO EXHIBITION, 1926

## Radio Press Star Receivers on Show

There are still a few days left in which to visit the National Radio Exhibition, which opened on September 4, in the New Hall at Olympia, and is to close on September 18. A few of the interesting exhibits are described and illustrated in the following pages, so that all can see the developments which are to make the coming season a notable one for every user of wireless apparatus.

**T**HE National Radio Exhibition, 1926, opened on September 4 in the New Hall at Olympia, and closing on September 18, is this year an all-British Exhibition.

Those who are able to do so should make a special point of visiting the



*An H.F. choke coil shown by the Varley Magnet Co.*

Exhibition this year, since the modern developments exemplified in the exhibits foreshadow an extremely interesting and successful season for every wireless enthusiast.

Among many other interesting components, Messrs. Beard & Fitch are exhibiting on Stand 83 their "Success" "Super" variable condenser, a straight-line frequency instrument. The Bowyer-Lowe Co., Ltd., are to be found at Stand 126, prominent among their components being gang-control variable condensers for single-control receivers.

The "Clearertone" valve holder, shown by Benjamin Electric, Ltd., on Stand 105, is now available with a grid condenser and leak as a permanent attachment. A self-contained rheostat is another novel exhibit by this firm. It is claimed that the Brown disc loud-speaker, which is on show on Stands 128 and 129 by S. G. Brown, Ltd., is practically immune from damage due to accidental falls; the diaphragm is protected with metal on both sides.

The wide-range of receivers manufactured by Burndept Wireless, Ltd., will be shown on Stands 140, 141, 144,

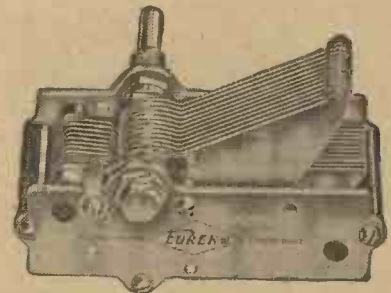

*The Portable Utilities Co., Ltd., are exhibiting this new "Eureka Orthocyclic" variable condenser.*

and 209, another feature of interest being the Auto Burndept System,

## The National Radio Exhibition, 1926—continued

which allows of the set being switched on and off from any room in the house.

The "Magnum" All-Season portable receiver, shown by Burne-Jones & Co., Ltd., on Stand 111, is so de-

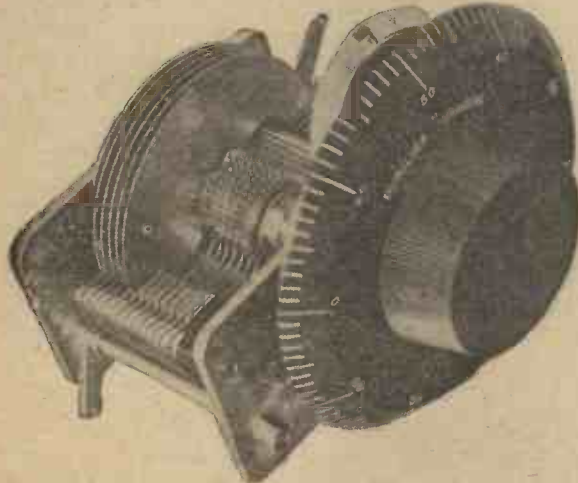

\* \* \*

The "Univane" variable condenser exhibited by the Dubilier Condenser Co. (1925), Ltd.

\* \* \*

signed that it may be withdrawn from its carrying case and used as an ordinary set in the home. On Stand 148 Clinax Radio Electric, Ltd., are exhibiting their A.C. and D.C. H.T. battery eliminators, for which very low running costs are claimed.

A comprehensive range of variable condensers and low-loss coils forms part of the exhibit by the Collinson Precision Screw Co., Ltd., on Stand 51. On Stands 86 and 87 are to be found the new "Point One" series of valves, manufactured by Messrs. A. C. Cossor, Ltd. Co-axial mounting of the electrodes is a special feature of these valves.

The "Duvarileak" is an interesting component shown by the Dubilier Condenser Co. (1925), Ltd., on Stand 154. This is a variable grid leak with a special type of resistance element,



One of the pins of the "Ediswan" valves is sealed to prevent unauthorised use before purchase by the customer.

for which constancy of values is claimed.

In addition to their usual products, Messrs. J. J. Eastick & Sons are exhibiting, on Stands 54 and 231, the "Ealex" semi-automatic light-



The "Indigraph" vernier dial is produced by the Igranic Electric Co., Ltd.

ning arrester and lead-in-tube, which may be worked from inside the house.

Those who use receivers which make heavy demands on the high-tension battery will be interested in Messrs. Ever Ready Co.'s exhibits on Stand 100, a special type of battery having been produced for this purpose.

The range of "Efesca" components, shown by Falk, Stadelmann & Co., Ltd., on Stand 114, has been augmented by new components inspired by the latest radio developments, particularly in the direction of methods of high-frequency coupling.

The "Formo" vernier dial, exhibited by The Formo Co., on Stand 78, is claimed to have a silent drive free from backlash, being entirely



The standard model "Dragon" Amplion loud-speaker, shown by Alfred Graham & Co.

enclosed in a bakelite moulding, with a window for the scale.

Messrs. Gambrell Bros., Ltd., are showing on Stand 90 a large range of new components, in addition to their well-known coils. The "Lotus" Buoyancy valve-holder is now fitted with terminals as well as soldering tags. This component will be on show on Stand 84 by Garnett, Whiteley & Co., Ltd., among other "Lotus" specialities.

The "RAO" type of high-tension accumulator, shown by the Hart Accumulator Co., Ltd., on Stand 56, has all the plates covered with perforated ebonite to prevent any dislodging of the active material from the plates.



Messrs. C. A. Vandervell & Co., Ltd., are showing this new "Musicola" loud-speaker.



## The National Radio Exhibition, 1926—continued

The superheterodyne outfit exhibited by the Igranic Electric Co., Ltd., on Stands 72 and 73, includes a short-wave unit, permitting of reception between 40 and 100 metres. A new coil-

the comprehensive series of building kits and complete receivers manufactured by the Peto-Scott Co., Ltd. Specimens of screened coils and transformers, neutralising condensers, etc.,

On Stands 116 and 43 will be found numerous types of receivers shown by A. J. Stevens & Co., Ltd. Among other features, the cabinet work of many of these instruments merits special attention. Battery charging

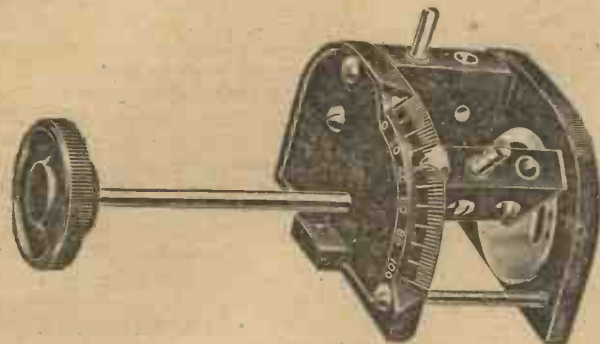

Messrs. Radio Communication Co., Ltd., are showing a coil holder provided with a scale and pointer to indicate coupling positions.



holder produced by the London & Provincial Radio Co. (Stand 6) is fitted with an indicating dial to indicate the exact degree of coupling between two coils from 0 to 90 degrees.

A new form of balancing condenser is a feature of interest shown by L. McMichael, Ltd., on Stand 142. It is claimed that the range of P.M. valves, shown by the Mullard Wireless Service

also form part of the exhibits on these stands.

Messrs. Radio Instruments, Ltd., are showing on Stands 145 and 147, together with many other components and complete receivers, a new pair of push-pull transformers.

On Stand Radio Press Ltd., are exhibiting, in addition to a complete range of Radio Press publications, in-



An S.L.F. condenser exhibited by the Formo Company.

apparatus forms the principal exhibit by the Tudoradio Co., Ltd., on Stand 10.

Ebonite panels, tubes and rods for all wireless purposes are to be found

### RADIO PRESS SETS AT THE EXHIBITION

The following Radio Press Star Sets, among others, will be exhibited on Stand

The "Elstree Six" (described in June *Modern Wireless*)

The "Elstree Solodyne" and The "Mewflex" (described in September *Modern Wireless*)

The "Night Hawk" and The "Distaflex Two" (described in this issue).

Co., Ltd., on Stands 136 and 138, covers every requirement of the broadcasting public, the distinctive features of the P.M. filament being retained in every valve.

The components shown by the Ormond Engineering Co., Ltd., on Stand 70, include an air dielectric fixed

cluding books and envelopes, a number of Radio Press Star receivers.

The Sel-Ezi Wireless Supply Co., Ltd., are making a special show of the "Thermo" fixed condensers, in addition to many other exhibits, on Stand 88.

on Stand 31, where Trelleborgs Ebonite Works, Ltd., are exhibiting their products.

Recent productions by Wright & Weaire, shown on Stand 224, include a filament rheostat and a non-microphonic valve holder.



A tapped resistance shown by Burne-Jones & Co., Ltd.



condenser with celluloid cover, and a special "Dual Indicator" dial. In addition to their usual ebonite products, the Paragon Rubber Manufacturing Co., Ltd., are exhibiting on Stand 7 a new ebonite battery container, the "Monobloc."

On Stands 161 and 259 will be found

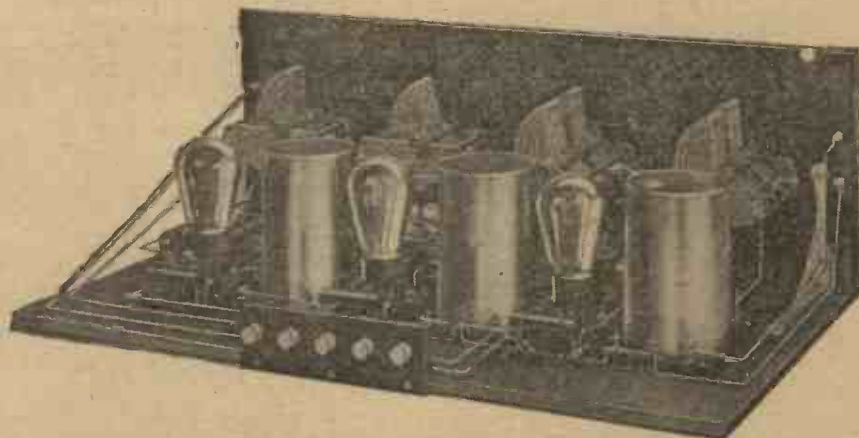

The "Mewflex" is one of the Radio Press Star Sets which will be on view at the Exhibition.

## OUR READERS' VIEWS

### HOWLING IN A SHORT-WAVE RECEIVER

SIR,—In answer to Mr. Benson's letter in the current WIRELESS CONSTRUCTOR on the subject of audio-frequency howling in a short-wave receiver, I think he will find one of the following alterations will remedy the fault he mentions:—

First, alter the value of the grid-leak; he may find that he has to use a very much higher value than he uses at present.

Secondly, alter the value of the choke coil. I use a coil holder into which I can plug different sizes of coils.

If neither of these remedy it he must change the type of valve he is using. I find that the best valve to use is one which will oscillate freely with a very small high-tension voltage. I have found that this howl will occur if either of these things are wrong.

Yours faithfully,  
W. H. JORDAN.

Battersea.

SIR,—With regard to the letter from Mr. M. S. Benson, of Cheltenham, in last month's WIRELESS CONSTRUCTOR, I am glad to know that I am not alone in experiencing this somewhat puzzling trouble. For some time now my short-wave receiver (also to a WIRELESS CONSTRUCTOR design) has been rather apt to burst into a high-pitched whistle just before going out of oscillation, yet several of my friends with very similar receivers have had no trouble in this direction. The L.F. transformer seems to have something to do with it in my case, and possibly the L.F. choke in Mr. Benson's, since the trouble is not present when I listen on a detector only.

I should be very interested to know whether any of your readers has succeeded in curing this howl.

Thanking you for the splendid designs published in the WIRELESS CONSTRUCTOR,

I am,  
Yours faithfully,  
R. L. SPOONER.

Wandsworth Common.

Have You Seen the Announcement on Page 1063?

### SHORT-WAVE AERIAL SYSTEMS

SIR,—Referring to the article in the August issue of THE WIRELESS CONSTRUCTOR, by Mr. G. T. Kelsey, entitled "For the Short-Wave Beginner," I feel that the author has omitted an important point. When the two aerials have been arranged as he suggests, and the lengths carefully matched off, two series condensers, one in each down lead, should be employed to tune the aerial circuit. It is plain that unless this is done the effects of the symmetrical aerial system are nullified, or at least hindered. If a parallel condenser were used, it would be a different matter, since the arrangement of aerial, counterpoise, and tuned circuit would then be symmetrical.

Yours faithfully,  
D. M. BENTLEY.

Dublin.

### A NEW RADIO PRESS ENVELOPE

On page 1124 in this issue will be found details of Radio Press Envelope No. 14, which gives constructional details of an instrument of permanent value to every listener and experimenter.

# SUCCESS

## RADIO PRODUCTS

For PERFECT RADIO RECEPTION

### "SUCCESS" SUPER CONDENSER

List No. 144.

#### ULTRA LOW LOSS S.L.F.

Minimum Dielectric Loss. Skeleton End Plates. Grounded Rotor. Spring Pigtails. Ball Bearing. 100 to 1 Slow Motion. Provision for quick searching. No Backlash. Lacquered Brass Throughout.

.0005 mfd. Complete 18/6 !!  
.0003 " " " 18/- !!



### "SUCCESS" VERNIER DIAL

List No. 141.

RATIO 100-1. NO GEARS. NO FRICTION drive discs. Fast or slow movement. No screwing to panel. Will fit any condenser spindle. Slip it on and tighten the screw. No special tools required. Absolutely NO BACKLASH. Nothing to get out of order. Simplicity itself. Solid and robust construction. Black fluted knob.

PRICE . . . . . 5/9



See our full range of Radio Components at National Radio Exhibition, STAND No. 83.

MANUFACTURED BY

## BEARD & FITCH, LTD.

Engineers,

34-36 Aylesbury St., LONDON, E.C.1.

Telephone: CLERKENWELL 8941-2.

# WHY ARE SCREENED COILS USED?

By J. H. REYNER

B.Sc. (Hons.), A.C.G.I., D.I.C., A.M.I.E.E.

*Mr. Reyner has devoted a large amount of time to research work directed towards obtaining highly efficient tuned circuits in the high-frequency stages of receivers. He explains fully here why the screened coil has been developed, and the advantages gained by the use of this type of coil.*

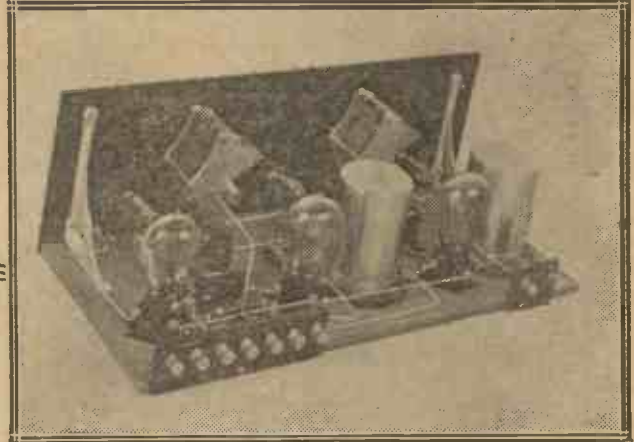

**T**HERE is an increasing tendency towards the use of screened coils in high-frequency amplifiers. Several of the sets which have been described recently have contained these new components, and a particular example is the "Distaflex Two," described in this issue, in which the high-frequency tuning circuits are all shielded.

Many readers will have wondered what the exact purpose of this screening is, what advantage is gained, and how the coils actually work.

### Coil Interaction

The object of the screening is twofold. First it is to prevent the magnetic field of the coil from producing any effect on neighbouring portions of the circuit. All my readers will know

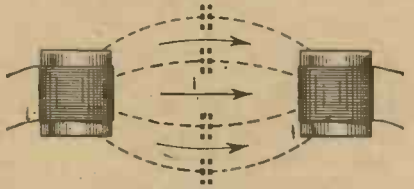

Fig. 1.—Representing the capacity coupling between two unshielded coils.

the trouble which can be caused by actual magnetic coupling between coils in different portions of a receiver. Not only does this often give rise to self-oscillation in the receiver, preventing it from being brought to its most sensitive condition, but it also destroys the selectivity of the arrangement.

If we have three tuned circuits, and we are attempting to receive a station operating on a wavelength very close to that of the local station, then if the circuits are efficient we can perhaps exercise such a filtering or selective action in the three tuned circuits that the local station is practically eliminated, and the station required is brought in at good strength.

### A Cumulative Effect

The signals from the local station in such a case would be successively reduced in the three tuned circuits. In the first circuit they will probably be

*By incorporating screened coils in a receiver a compact layout can be secured without loss of efficiency.*

considerably stronger than those of the station which we wish to receive. In the second circuit we have a second filtering action, and this probably reduces the strength of the local station to something approximately of the same order as that of the required station. The third circuit completes the work, and reduces the local station still further until it is negligible as compared with the distant station to which we are tuning.

### Stray Coupling and Selectivity

It will be obvious that if we permit any coupling from the front to the back of the receiver, i.e., between the first and third circuits direct, we shall cut out altogether the eliminating effects of the middle circuit. Instead of obtaining the distant station considerably stronger than the local station therefore, we shall obtain both at equal strengths, as we should normally do with two circuits only. In other words our selectivity has been completely destroyed by this unwanted coupling between the circuits.

### Obtaining Zero Coupling

Now this question of magnetic coupling has long been appreciated, and in order to avoid it, designers of circuits have placed their coils at such angles that the magnetic coupling between them was very nearly zero. There are several possible ways of arranging the coils in such a manner that the coupling between all of them is essentially zero.

### Capacity Effects

This does not provide a complete solution of the case, however, because of a second effect which has to be considered, and this is the capacity coupling. An ordinary condenser has a capacity by virtue of the fact that the different plates are placed in proximity to each other, but are at different high-frequency potentials. Mr.

Harris has already explained the effect of capacity in his Talks to Beginners. A little thought will show that any coils in a wireless receiver have different high-frequency potentials between them, and there will consequently be an appreciable capacity effect between the various circuits.

### Practical Research

Recent developments have shown that this capacity coupling was of a much greater order than was previously thought to be the case. Some experiments which I carried out showed that at a distance of from 6 to 8 inches with an ordinary cylindrical coil about 3 inches in diameter, the capacity effect was greater than the magnetic coupling, and that in certain circumstances it was absolutely impossible to reduce the coupling between the coils to zero.

### Relative Positions of Coils

Up to a certain distance we have the effects of the magnetic coupling and the capacity coupling acting together, and we can so place the coils that these two balance out, so that we

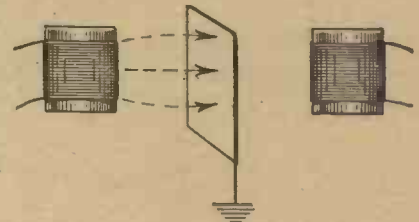

Fig. 2.—The introduction of an earthed screen provides an effective barrier to the capacitive coupling.

can obtain positions of zero coupling. It may be remarked in passing that these actual true zero couplings are by no means in the positions which one would expect them to be, and if we were dependent upon actual correct

## Why are Screened Coils Used?—continued

spacing of the coils to obtain zero coupling between the various circuits, the design of sets suitable for construction by the average amateur from the details published in technical journals would be well nigh impossible.

To revert to the question of coupling, however, we find that outside a certain critical distance the effect of the capacity coupling absolutely swamps that of the magnetic coupling, and it is impossible to obtain a position where the coupling is zero. It

we do not require it that the screened coils have been developed.

### Eliminating Direct Pick-up

The second object of the screened coils is the prevention of direct pick-up. The coils of a receiver all act as very small aerials. Whatever the actual position of the coil itself, it will pick up a small quantity of energy either acting as a miniature frame aerial, or as a very small vertical aerial, and the result is that if the

quently a capacity coupling between them. This will result in capacity current flowing between the two bodies, and consequently a certain amount of energy will be transferred between the two.

### Inserting a Screen

We can prevent this transfer of energy by inserting between the two bodies a plate which is connected to earth. The earth is at the lowest potential in any circuit, and small variations take place about this fixed potential point. The surface of the earth plate thus prevents the voltage variations on the first body from producing any effect beyond the screen. What energy is lost is not transferred to the second body at all, but only to earth. Such an arrangement therefore effectively eliminates the capacity coupling between the circuits.

### Magnetic Coupling

When we come to consider the magnetic coupling the position is a little more complicated. It is often thought that the insertion of a magnetic screen of some sort will actually prevent the magnetic field from penetrating the screen. This is not the case, and the screening effect is really produced by a totally different mechanism.

Let us consider a simple coil of wire as shown in Fig. 3. If we have a varying current flowing round this coil, then there will be a magnetic field produced which will spread out from the coil axially somewhat in the manner shown by the dotted lines. If then we bring another coil close to the first coil, some of the magnetic field produced by the first coil will upset the second, and will set up currents in the

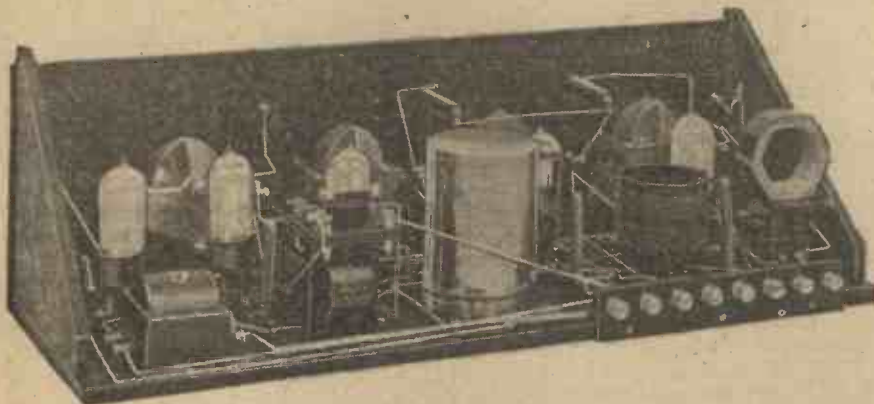

The "Five Fifteen" Receiver, described in the July issue of "The Wireless Constructor," utilised one screened and two unscreened coils.

is only because of the considerable developments which we have made in the art of high-frequency amplification generally that these points are now coming to light, and we have to find methods of overcoming the difficulties.

### How Screened Coils Help

In an efficient, high-frequency amplifier we wish the signals received from the aerial to pass through the tuning circuits, and then through the appropriate valves in the correct

set is operated close to a transmitting station, these signals will be picked up directly, and will not be subjected to the filtering action of tuned circuits. This, again, will result in destroying the selectivity of the receiver. If the circuits are enclosed in screening cases, it is possible to prevent the waves from affecting the coils directly, as we shall see shortly.

### The Function of Screens

The question to be considered now, therefore, is exactly how the screening produces the shielding effect that we require. We have seen that there are two effects to be considered. First that of the magnetic field, and secondly that of the capacity coupling between the coils.

Many people are under the impression that these new screened coils only eliminate the capacity coupling, and that in order to eliminate any magnetic coupling some form of magnetic metal, such as iron, must be used for the screening cases. This, as a matter of fact, is quite incorrect. The screens shield the effect of both the magnetic and the capacity coupling, and, indeed, if iron were used for the screens themselves the results would be so poor as to render the screens practically useless.

### Capacity Coupling

Let us consider the effect of capacity coupling first of all. In Fig. 1 we have two coils at different potentials to each other, and there is conse-

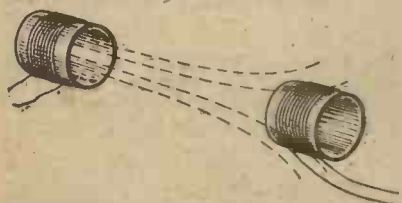

Fig. 3.—Showing how the magnetic field produced from one coil will affect another in the vicinity when no screens are used.

sequence. If any energy is allowed to take alternative paths, we are going to suffer from a loss of efficiency. In addition to the direct leakage of energy from the front of the set right through on to the last tuned circuit which we have already considered, there are all manner of other possible stray paths for the energy, by which it can return and circulate in eddies as it were, and as long as this is permitted we cannot obtain the maximum efficiency. It is to avoid this filtering away of the energy in channels where

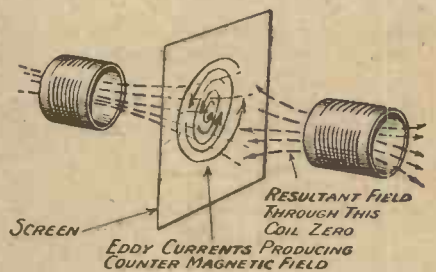

Fig. 4.—The magnetic field from one coil will produce eddy currents in the screen which will cancel out the effect of the field.

second coil. This is the phenomenon known as magnetic coupling.

### Eddy Currents

Let us now place a sheet of copper a short distance away from the first coil, as shown in Fig. 4. The effect of the magnetic field reaching this copper screen will be to produce very small circulating currents in this sheet. The copper behaves as if it consisted of a large number of very small single-turn coils, each of which would have its appropriate current induced therein.

## Why are Screened Coils Used?—continued.

These currents are known as "eddy currents."

### What They Do

Now, the important fact about these eddy currents is this: These currents

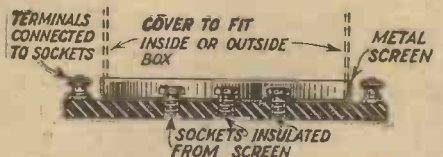

EARTH TERMINAL CONNECTED TO SCREEN

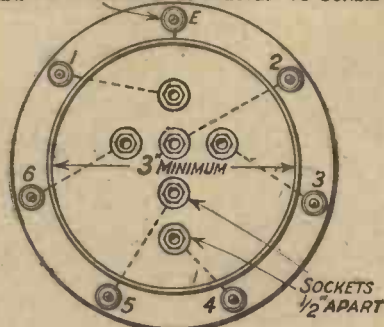

Fig. 5.—The standard mounting of the type of screened coil developed by the author is shown here.

in turn produce magnetic fields of their own, and the average effect of all the eddy currents is to produce a fairly large magnetic field. It can be shown theoretically and confirmed by experiment that the direction and magnitude of this magnetic field produced by the combined effect of all the eddy currents in the copper screen are practically equal and opposite to those produced by the coil itself. This means that on the other side of the screen the magnetic field due to the first coil is practically cancelled out by the magnetic field produced by the eddy currents in the screen.

The screen therefore does not wipe out the magnetic field of the coil in any way, but it produces an equal and opposite magnetic field which cancels out the effect of the original field. Obviously the results are just the same, but the actual production of the results is achieved in a slightly different manner.

### Practical Problems

Now, the difficulty with magnetic screening is this: In order to achieve complete shielding it is necessary to enclose the coil on all sides in a metal box. Capacity shielding may be achieved fairly simply by a single earth plate placed in an appropriate position, but for magnetic shielding a complete cover is required. The screened coils which have been developed therefore are designed to be practically complete, the only holes in the box being those necessary in order to bring the connections through the base.

### Losses Due to the Screen

The question of the size of the screen is one of considerable importance, and no little experimental work was done before the actual dimensions of the screens were decided. It will be apparent at once that the production of eddy currents in the copper screens demands the expenditure of a certain amount of energy. This absorption of energy from the coil is bound to detract from its efficiency to a small extent, and will show up as an increase in the effective resistance of the coil.

### Importance of Screen Design

It might be thought at first that this would render the whole principle useless, but this is not the case. The further away we go from the coil, the less is the strength of the magnetic field, and correspondingly the less will be the eddy currents producing the counter field outside the screen. Some experiments were therefore carried out in order to find the effect on the resistance of the coil of placing the screen at varying distances, and it was found that if the screen was placed within a certain distance, the losses introduced were very considerable.

### Material for Screens

If, on the other hand, the screen was kept at least half an inch away from the coil in a radial direction, and one inch away from the actual end of the coil axially at each end, then the extra resistance introduced into the circuit was not excessive. The metal of the screen had considerable effect, the lower the resistance of the metal the less being the loss introduced. Copper or aluminium is necessary, therefore.

### Standard Dimensions

Even with this arrangement, however, the coils would have been somewhat bulky if the usual 3-in. diameter coils had been used, as this would have necessitated 4-in. screens. As a result of a certain amount of experiment, therefore, it was decided that reasonably efficient results could be obtained with a 2-in. diameter coil and a 3-in. to 3½-in. diameter screen, which is the standard pattern now on the market.

### Effect of Wavelength Range

One other point may be mentioned in connection with the use of these coils, and that is that the presence of a screen not only alters the effective resistance of the coil to a small extent, but also the inductance. This means that if the coil is tuned in to a certain wavelength with the screen in place, and the screening cover is then removed, the tune of the circuit will alter considerably, and an increase in tuning condenser will be required in order to restore the circuit to its tuned condition.



Build your own loud speaker for the summer.

Summer Time! To be spent in the garden basking in the sun—your diversion the invisible entertainer, radio. It is a thing to look forward to, this restfulness and to the full power and mellow music of the "Lissenola." And the cost?—negligible; for your finished loud speaker works out at less than 15/- (the "Lissenola" is 13/6, and with it we give you full-size diagrams and clear instructions how to build a proved horn for a few pence). You could not have a better loud speaker whatever price you paid.

If you prefer it you can easily convert the "Lissenola" to carry a cone or any other diaphragm working on the reed principle by attaching the Lissen Reed (1/- extra). In addition, if you possess a gramophone you have only to substitute the Lissenola for the sound-box to convert it at once into a radio loud speaker.



Ask your dealer to show you the

**LISSENOLA**

LISSEN LIMITED,  
26-30, Friars Lane,  
Richmond, Surrey.

Managing Director: Thomas N. Cole

## TRACING TROUBLE IN A SINGLE-VALVE SET

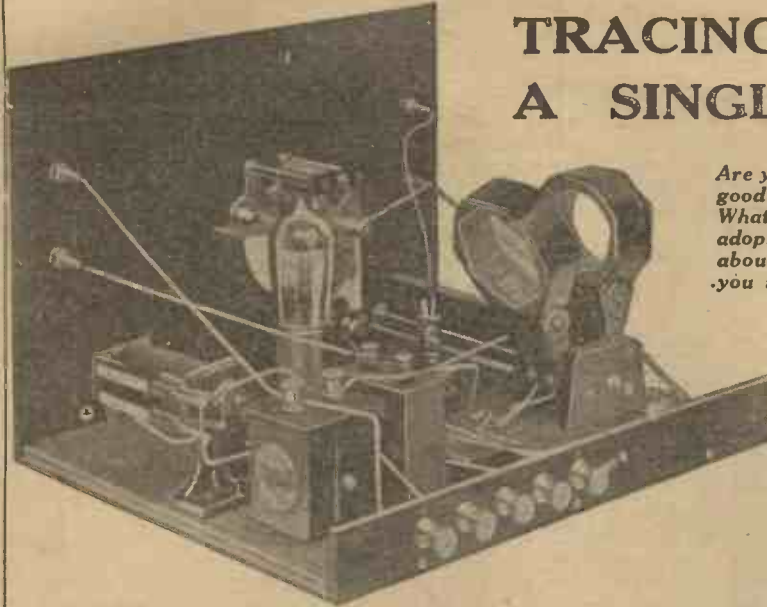

Are you helpless when your set ceases to give good signals or breaks down altogether? What system of locating the trouble do you adopt? If you are uncertain how to set about it, these notes will be of assistance to you in discovering the cause of any simple fault in your set.

A faulty connection to the moving block of a "swinging" coil-holder is often responsible for puzzling noises.

IN this article the writer proposes to deal with the possible sources of trouble in single-valve receivers, whether arising from faulty design, construction, or unforeseen events after the set has been in use. From time to time articles have appeared which should enable the beginner to trace faults in either high-frequency or low-frequency amplifiers, and, with the help of these few remarks, he should be able to locate trouble in practically any type of radio receiver.

### A Simple Circuit

The diagram in Fig. 1 shows the ordinary conventional single-valve circuit, reaction in this case being controlled by means of variable coupling between the coils, and the points at which trouble may possibly occur are numbered.

Dealing with these points in numerical order, we may summarise the symptoms in each case.

### Aerial Disconnection

Should there be a break at (1), the set will tend to oscillate hard, and signals will, of course, be abnormally weak. Probably the quickest way of determining whether this has really occurred is to detach the aerial lead from the set, and note whether much difference in signal strength results. If the aerial really is connected, signals should, of course, become very much weaker than they are. If, however, there is a long lead to the earthing switch, and the aerial has become disconnected at that point, although there will be a difference in signals when the lead is taken off the aerial terminal, it should not be very noticeable.

### A Useful Test

A break at point (2), i.e., anywhere in the A.T.I., will, generally speaking, be very simple to detect, since, should the reader be anywhere near an electric railway or tramway, or even have electric-light mains within a short distance of his house, a hum will immediately be heard on breaking the circuit at this point. Should there be no guide of this nature, the set will, of course, refuse to oscillate, and no signals other than perhaps very weak traces of the local station, if the reader is very close to it, will be heard.

If two fingers are placed across the points which should normally be the extremities of this coil (a break being suspected), a sharp click will generally indicate that one is present.

### Examine the Earth Lead

Point (3) indicates a break of any description anywhere between the set and the earth. This point is apt to be a little troublesome in some circumstances, since a set may apparently be functioning fairly well, even with the earth disconnected. Generally, however, a faulty earth connection will cause instability in the receiver, and, most noticeable of all, severe hand-capacity effects when the condenser across the A.T.I. is approached. One quite reliable way of making sure that there really is a break in the earth lead is to switch on the set, listen to a fairly weak signal, and, with a moistened finger, touch the gas-pipe or water-pipe. A click or sudden disappearance of the signal may be taken as a fairly sure indication that the earth lead is in trouble somewhere.

A fault at point (4) is a very simple matter to detect, since no H.T. cur-

rent can flow through the 'phones, and on disconnecting one tag of the 'phones the usually healthy "plop" will not be heard.

### Testing Condensers

(5) indicates a faulty grid-condenser, or a defective connection to one side of it. Here again, should the reader be close to any form of A.C. supply, a hum will most probably be heard. Failing any definite indication of a fault in this position, it will be advisable to test the condenser with a 4½-volt flash-lamp battery and a pair of headphones. A click heard on "making" the circuit, but not on breaking it, shows that the condenser is in order. No click at all will, of course, prove that the circuit is completely broken at some point. For this reason do not connect the leads from the battery and headphones directly across the condenser, but from the grid pin of the detector valve to the point at which the lead from the grid condenser joins the A.T.I. Any fault in the leads from the condenser will thus be shown up. Actually the soundest method is probably the substitution of another condenser.

### Grid Leak Troubles

A faulty grid-leak (6) is, as a rule, much more easy to detect, aural methods being satisfactory in nearly

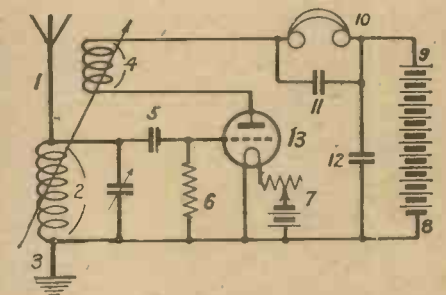

Fig. 1.—The numbers on this circuit diagram are referred to in the article as a convenient way of checking the circuit.

every case. A loud howl or ticking noise when the reaction coupling is fairly tight is a sure sign that the grid-leak is either cut right out of circuit or of much too high a value.

# The 'far better' condenser—

## THE NEW ORMOND S.L.F. CONDENSER

### Specification :

The new ORMOND Precision Straight Line Frequency Condenser embodies the famous ORMOND Slow Motion Friction Drive. Special ball bearings ensure a smooth action, giving a liquid-like movement, facilitating precise tuning adjustments with noiseless operation.

Its construction is very robust. It has bright brass vanes, perfectly rigid, and the heavily nickelled and polished end-plates ensure minimum eddy current losses.

The moving vanes are connected to the frame, thus eliminating stray capacity effects.

Special shaped vanes give high maximum and low minimum capacity with true S.L.F. readings throughout full 180 scale.

Extremely low Radio frequency losses.

Special method of mounting the fixed vanes reduces dielectric losses to a minimum. Highest quality scientific instrument finish, handsome bakelite combined knob and 4-inch dial, engraved with 180 separate degrees, and separate slow motion knob.

It has an anti-capacity earthing shield which may be fitted, insulated from the condenser, and earthed by a separate connection. This is particularly useful when condenser is used in circuits where both electrodes are at radio frequency potential. Easy to mount, one and three hole fixing.

Terminals and soldering tags for connections.

### Note the low prices :

·00025 micro farad	...	19/-
·00035 " "	...	19/6
·0005 " "	...	20/-

Complete with Knob and 4-in. Dial.

Without Friction Control but with 3-in. Dial and including Hand Capacity Shield.

·00025 micro farad	...	11/-
·00035 " "	...	11/6
·0005 " "	...	12/-

Knob and Dial.  
Fixed with GRUB SCREWS

Knob & 4" Dial  
Beautifully  
Finished

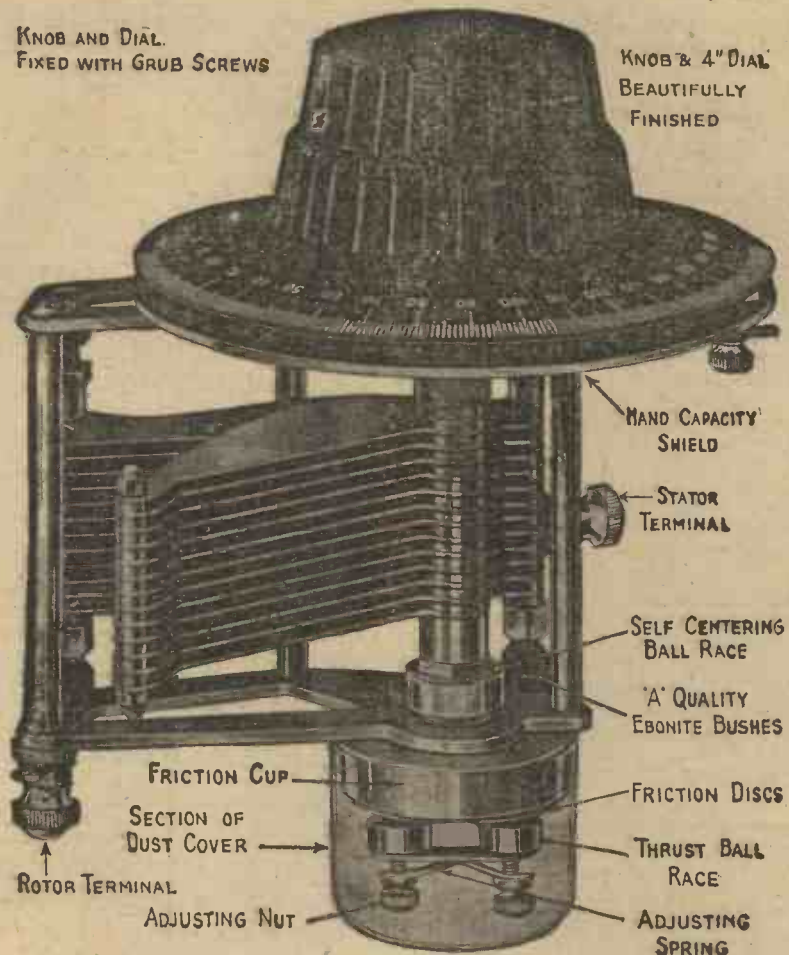

PATENT APPLIED FOR

This is the ORMOND S.L.F. CONDENSER which has fully demonstrated our claim for its superiority. It is made with exact precision in our own factories by British labour from the finest quality materials and designed to be scientifically correct. The specification at side will interest you—certainly the low prices quoted there should cause you to join the ranks of the thousands who are now changing over to ORMOND S.L.F. 'SLOW MOTION' CONDENSERS.

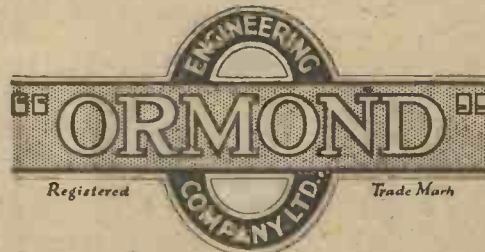

199-205, Pentonville Road, King's Cross, London, N.1

Telephone: Clerkenwell 9344-5-6.

Telegrams: "Ormondengi, Kinross."

FACTORY: WHISKIN STREET, CLERKENWELL, E.C.1

## Tracing Trouble in a Single-Valve Set—continued

Serious distortion also results sometimes from a defective or unsuitable grid-leak.

### Low-tension Circuit

(7) is intended to cover either a break in the leads from the low-tension battery, a break in the leads from the L.T. terminals in the valve itself, or a defective filament rheostat. Any of these will, of course, be shown by the failure of the valve to light. Substitution of another valve should be tried before searching for a fault, however, in case the one normally in use has been burnt out.

### Is the H.T. Connected?

A break in the circuit at point (8) will result in total absence of signals, and is best detected by removing and replacing the wander plug from the negative end of the battery several times. If no vigorous clicks are heard it may be taken for granted that there is no connection from this point to the negative side of the L.T. battery, or, alternatively, that the circuit is broken at point (9), or somewhere in the H.T. battery itself. A high-reading voltmeter is the most useful way of decid-

ing whether there is any trouble with the battery, however. A break at (10) may be found by removing the telephone tag from the terminal which is connected to the positive H.T. terminal, and touching it upon the positive end of the battery. If signals then resume their normal strength it may be assumed that a faulty connection between the 'phones and the H.T. terminal was the cause of the trouble.

Any break in the H.T. circuit (i.e., at the points 8, 9, 10 or 4) will, of course, result in the total absence of signals, and also of clicks on removing the 'phones from their terminals, and thus be fairly easily diagnosed at once.

### Telephone Condenser

A defective condenser across the telephones (point 11) may cause various forms of trouble. If there is a short-circuit in this condenser, or a serious leak amounting to a "short," signals will be absent or very weak. If there is a break, either in the condenser itself or in the leads to it, no difference other than the fact that the set will not oscillate quite so readily as usual may be noticed. On the other hand, signals may sound "tinny" or

"thin," particularly if a note magnifier is used after the detector. In this case an audio-frequency howl may be set up.

### Shunt the H.T. Battery

The absence of a large condenser in position (12) is also not very noticeable in some circumstances, for instance, when the H.T. battery is new and giving its full-rated voltage. With an older battery, however, its absence will be shown by crackling or "frying" noises, or, if note-magnifiers are used, perhaps a tendency to howl when the set is just on the oscillation point.

### A Common Fault

Last, but by no means least, is the point (13), intended to cover trouble either in the valve itself or in the connections to the pins. All kinds of puzzling effects that do not seem to be due to any of the other kinds of trouble may arise from faulty connections between the pins on the valve itself and the sockets of the holder. The valve should periodically be removed and the legs opened out or scraped clean with a penknife.

W. L. S.

# LUSTROLUX

## The Safety Valve

2.8v  
4v 20as  
THE OLD WAY

2v  
2v 40a  
LUSTROLUX WAY

**UNLESS** you use Lustrolux your dull emitter valves call for "two-point-something" or "three-point-something" volts. You use a 4-volt supply, feed through the Rheostat—and trust to luck that the valve isn't over-supplied.

**LUSTROLUX** British made Valves put an end to all that! Whether you want a '06 H.F. Det. or L.F., or a power valve at '34 amps., the Lustrolux Valve calls for **2 VOLTS ONLY**. Arrange your cells in parallel and get added hours per charge. Lustrolux reception is perfection, and Lustrolux costs are amazingly low. '06 Dull Emitters, 9/-, '34 Power Valve, 11/-.

Prices post free.

Ask your Dealer.

Sold also by Lewis's Ltd., Manchester and Liverpool, and

**LUSTROLUX LTD.,**  
West Bollington, nr. Macclesfield.  
Send for Catalogue G.

More Volume

# FARADEx

## COILS

Better Tone

R. D. LTD. LONDON

**SOLENOID WINDING**  
**AIR SPACED** and  
**SELF-SUPPORTING.**

These are the outstanding features of the new

# FARADEx

## EXTRA LOW LOSS COILS.

**LOW H.F. RESISTANCE**  
**MAXIMUM INDUCTANCE**

**MORE VOLUME AND**  
**BETTER TONE.**

Exceptional Strength & Rigidity  
Low Loss Coil Mount of Pleasing Design Eliminating Side Plates.

See these wonderful Coils on Stand 254 Gallery.

An Eminent Scientist's Opinion of our Faradex Coils.

Messrs. Rooke Brothers. July 9th, 1926.

Dear Sirs,—You will be interested to know that I have now put to a practical reception test the following range of your FARADEx COILS, Nos. 25, 35, 50, 75, 100, 150, 200, 250 and 300, against other well-known makes of coil. As a result I have found a notable increase of volume on all the various wave-lengths received, including Continental stations. There is also apparent an improved quality or purity of tone, but the increased volume is undoubted and remarkable. I can therefore, from practical test, thoroughly recommend your Inductance Coils for radio purposes as their efficiency is evident.

From A. P. THURSTON, Consulting Engineer,  
D.Sc. (Lond.), F.R.Ae.S., M.I.A.E., M.I.Ae.E., A.M.I.M.E.

Sizes:	25	35	40	50	60	75	100	150	200	250	300	400	500
Prices:	2/-	2/-	2/-	2/-	2/3	2/6	2/9	3/-	3/3	3/6	3/9	4/9	6/-

If you cannot obtain these Coils, write direct, giving name and address of your local dealer.

**ROOKE BROTHERS LIMITED**

WORKS & OFFICES: 55, CADDINGTON STREET, LONDON, N.W.1.



Contributing to  
the success of  
the famous  
"Elstree Six"

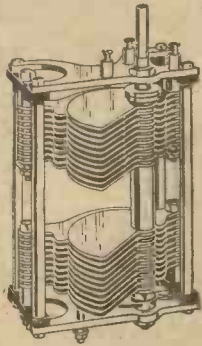

**CYLDON**

.0005 Square Law  
**DUAL CONDENSERS**

Price **27/6** each

Set of four—£5 10s.

.0003 mfd. 25/- each  
Complete with 4in. Knob Dial.

**Other Cyldon Condensers**

Capacity	Price	S.L.F.	Price
.001 Mfd.	21/-	.0005 Mfd.	15/6
.0005 "	17/6	.00035 "	15/-
.0003 "	16/6	.00025 "	14/6
.00025 "	16/-		
.0602 "	15/6	4" Knob Dial	
		With 4" Knob Dial	2/- extra

THE CYLDON DUAL CONDENSER comprises two .0005 mfd. Condensers mounted in one frame with special Grounded Rotor (on a common spindle) giving surprising smoothness and ease of action.



Cyldon Condensers from your dealer or post free from makers.

**SYDNEY S. BIRD & SONS,**

"Cyldon" Works, Sarnesfield Road, Enfield Town, MIDDLESEX.

Telephone: ENFIELD 0672.

**A Profitable Investment**

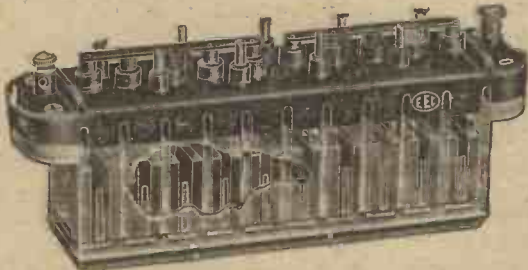

**E.E.C. Monoblock "H.T." Accumulators**

Dull Emitter Valves have done much towards reducing the expense incurred in recharging your L.T. Accumulators, but the wireless enthusiast still finds that the cost of H.T. Battery upkeep is a considerable item. This outlay can be more than halved by using the E.E.C. MONOBLOCK ACCUMULATORS, while at the same time wireless reception is immensely improved. Much of the noise attributed to atmospherics emanates from your dry battery. If you want perfect reception use Accumulator H.T.

20-volt Units in Moulded Glass Boxes. Tapped at every cell, with Grease Cup. Capacity 1,800 milliamps. Size 8½" x 1½" x 3½". Weight 2½ lb. Price 12/- per unit, charged in a dry state, and only needing addition of acid. 10-volt Units, same specification as above, but half the length, 6/-.

Send us your name and address on a postcard for a copy of our 44-page Radio Catalogue.

**Economic Electric Ltd** 10, FITZROY Sq. LONDON W. 1.

**EFESCA**

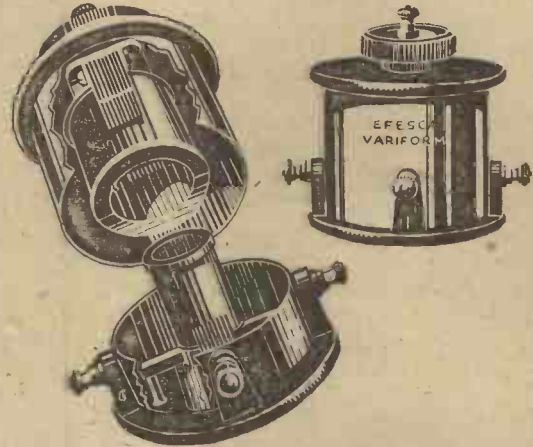

**VARIFORM**

PATENT

An epoch making departure in low frequency transformer design.

**T**HE wide variety of valves has inspired the production of the EFESCA "VARIFORM" LOW FREQUENCY TRANSFORMER, the primary impedance of which can be altered to suit different types of valves. This is achieved by winding the primary on a separate bobbin, which is detachable and interchangeable with others of different impedance values.

A series of five primary windings is available, giving ratios of 2 to 1, 3 to 1, 4 to 1, 5 to 1, and 6 to 1, enabling the transformer to be adjusted to any type of valve or circuit. The interchange is effected without disturbing the permanent transformer connections.

An incidental advantage is the ability to replace a burnt-out primary—the vulnerable part of all transformers—for a few shillings, instead of scrapping the lot.

With one primary bobbin: (specify Ratio required) Price each **30/-** Or with complete set of 5 interchangeable primary bobbins **40/-**

Wholesale only. Spare interchangeable bobbins, 3/6 each

**FALK, STADELMANN & CO. LTD.,**  
83/83, FARRINGTON ROAD, E.C. 1.

Ask your Wireless Dealer for EFESCA COMPONENTS or write for catalogue.

NATIONAL RADIO EXHIBITION OLYMPIA LONDON Stand 114.



A Puravox Loud Speaker for purity & Volume

# BENJAMIN



### VALVE HOLDER

This is the usual view of the Benjamin Valve Holder without attachments.

Price 2/9 each.

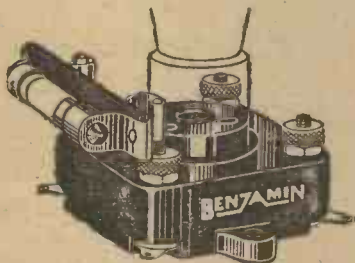

### VALVE HOLDER AND GRID LEAK

Nickel-plated copper clips on a rigid insulating bar carry a Dubilier Dumetohm 2 megohm Grid Leak. Wiring and space saved, perfect connections assured.

Price 5/3 complete.

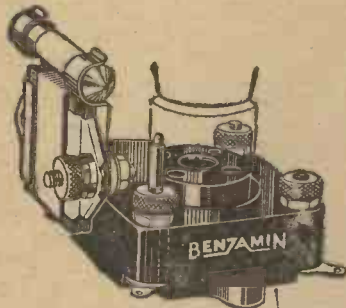

### VALVE HOLDER, GRID LEAK AND CONDENSER

The same as above but with the addition of a Dubilier Fixed Condenser (.0003 mfd.). Grid Leak can be in series or parallel. Wiring entirely dispensed with, space saved, installation simplified, connection troubles banished.

Price 7/- complete.

PATENT NOS. :  
222085—1923      250431—1925

REGD. DESIGN: No. 714847

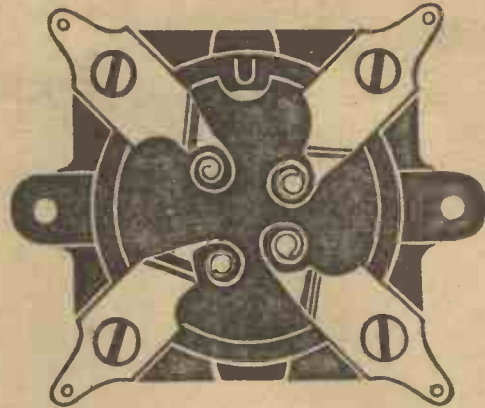

## The one-piece spring feature

This is a BENJAMIN Anti-Microphonic Valve Holder turned upside down. The four metal strips you see are the patent BENJAMIN one-piece springs—each a complete length of tempered metal, cut and shaped to form the soldering tag and the valve pin socket, and the spring.

Most anti-microphonic valve holders have in place of this two or three strips of metal soldered or rivetted together. In time, the joints work loose and become 'noisy.' The BENJAMIN Valve Holder with its one-piece spring feature overcomes this difficulty.

The BENJAMIN Valve Holder has also four other important features:—

- (1) It allows the valve to float in any direction.
- (2) Valves can be inserted or removed easily and safely.
- (3) Valve legs cannot possibly foul the baseboard.
- (4) Both terminals and soldering tags are provided.

This world-famous component, which trebles the life of your valves and completely disperses all microphonic noises, can be purchased either alone or with the attachments shown on the left. Sold by radio retailers everywhere.

# BENJAMIN

## Clearer Tone, Anti-microphonic VALVE HOLDER

British Made

THE BENJAMIN ELECTRIC LIMITED  
Brantwood Works, Tottenham, London, N.17

Benjamin—makers of things more useful

**S.P.18 RED SPOT**  
An excellent all-round-purpose Valve. Very effective as an L.F. amplifier, especially in last stage. Exceptionally good as a rectifier and very efficient as an H.F. amplifier. Fil. Volts: 1.6-1.8. Amps.: 0.3.

PRICE 14/-

**S.P.18 GREEN SPOT**  
Specially designed for resistance capacity and choke coupling. Also suitable for use in early stages of L.F. amplification. A very efficient H.F. Amplifier and even a better detector than Red Spot. Fil. Volts: 1.6-1.8. Amps.: 0.3.

PRICE 14/-

**S.P.18 BLUE SPOT**  
Extra high amplification Valve. With L.F. resistance-capacity coupling gives as much amplification as most valves with transformer. With a transformer, tremendous amplification. As an H.F. amplifier in stabilised circuits gives far greater amplification than otherwise obtainable. Takes only a fraction of the H.T. current taken by other valves. Fil. Volts: 1.6-1.8. Amps.: 0.09.

PRICE 14/-

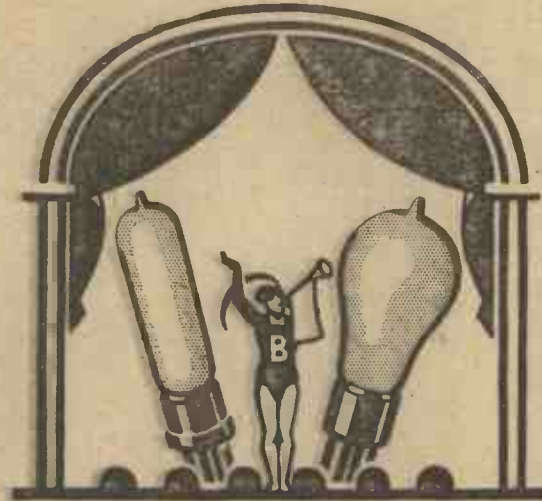

## Making their bow

EVERYONE knows the name BENJAMIN—makers of the world-famous Valve Holder. This season BENJAMIN will be doubly in the public eye—for a complete range of BENJAMIN RADIO VALVES is now on the market. In these valves are combined every recent discovery and advance in valve manufacture.

Greater amplification, greater output, less distortion, exceptionally good rectification, and extremely low filament consumption are among their more important features. Better results can be obtained from *any* receiving set if BENJAMIN VALVES are fitted.

Ask your dealer about them—or send to us for leaflet giving full particulars.

# BENJAMIN

---

## SHORTPATH

---

# RADIO VALVES

THE BENJAMIN ELECTRIC LTD.,  
Brantwood Works, Tottenham, N.17.

**S.P.55 RED SPOT**  
A perfect last-stage power Amplifier. Will handle an exceptional amount of power. Greater volume obtainable without distortion beginning. Excellent in all stages with transformer or choke coupling. Also gives good results as H.F. amplifier or detector. Fil. Volts: 5.5. Amps.: 0.25.

PRICE 18/6

**S.P.55 BLUE SPOT**  
An extra high amplification Valve with a moderate impedance. Designed specially for resistance and choke-coupled L.F. and for tuned anode H.F. Ideal for anode rectification. Fil. Volts: 5.5. Amps.: 0.09.

PRICE 18/6

**D.E.55.**  
A very good general-purpose Valve for H.F., L.F., or detector work. Gives splendid results where the super-efficient SHORT-PATH Valves are not suitable because of their "liveliness." One of the most economical Valves with L.T. and H.T. current. Fil. Volts: 5.5. Amp.: 0.09.

PRICE 18/6



# THE "CASSET" CRYSTAL SET

By H. BRAMFORD

The receiver described in this article will be found both selective and "flexible." It is suitable for the reception of Daventry as well as for stations in the lower band of wavelengths.

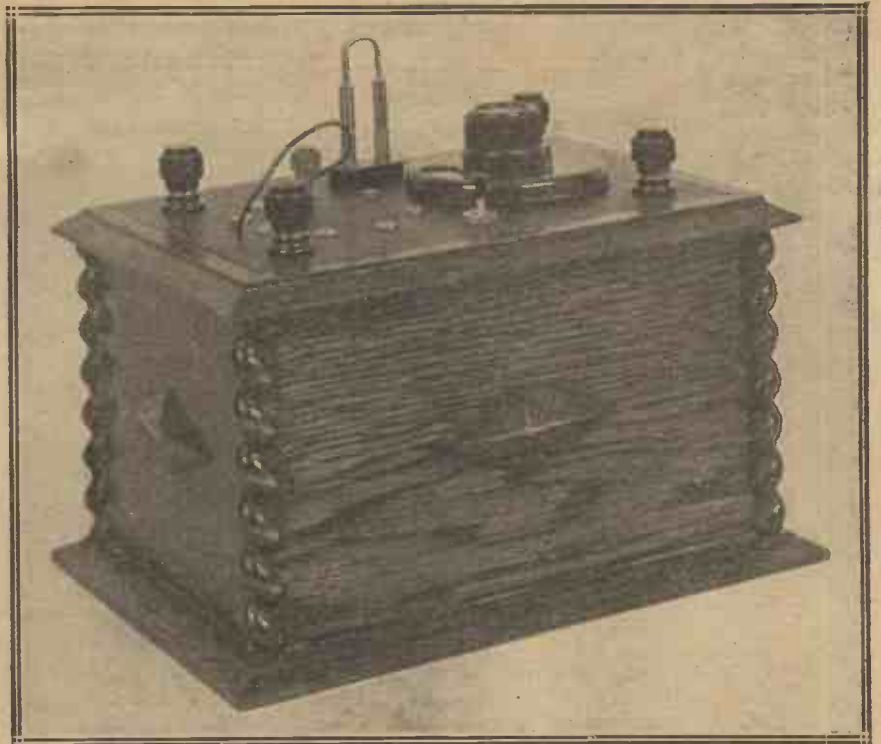

At the present time the keynote of efficiency in the design of crystal receivers is still simplicity, if the best results are to be obtained. It has undoubtedly been found that complications in the way of intricacies relating to circuits, or switching arrangements, or multi con-

amount of signal strength is desirable. The receiver about to be described in this article has therefore been designed with these points in mind, in addition to which the completed set presents a particularly neat and artistic appearance when made, rendering it most suitable as an ornamentation in any part of the home. Variometer tuning has been selected as being most efficient, as well as one of the most simple arrangements in operation.

A fixed condenser of .0001 microfarads is placed in series with the aerial for constant aerial tuning, and a "multiple fixed condenser" is connected across the variometer windings, to enable the set to be used with different sized aeri-als.

The material which was actually used for the construction of the set is listed below.

### BUILD THIS SET WITH

- One "Casket" cabinet (Camco).
- One ebonite panel measuring 7½ in. by 5 in. by ½ in.
- One variometer (Igranic Electric Co., Ltd.).
- One multiple fixed condenser (C.A.V.).
- One fixed condenser, .0001 (Dubilier Condenser Co.).
- One permanent detector (R.I., Ltd.).
- One coil socket with shorting plug.
- Four terminals (Belling Lee).
- Six Clix sockets (Autoveyors).
- One Clix plug (Autoveyors).
- Two 4 B.A. screws.
- Six 4 B.A. nuts.
- Glazite, and small piece of insulated flex.

Approximate cost, £2.

### Constructional Details

The actual construction of this receiver is a comparatively simple

matter. First drill the panel in accordance with the front of panel diagram. Particular care should be given to the drilling of the holes, which are mounted radially, as shown, to receive the Clix sockets, as they are placed to correspond with the "multiple fixed" condenser, mounted upon the back of the panel. When the panel has been drilled proceed to mount the four terminals, followed by the single-hole fixing variometer, the loading coil plug and socket, and the crystal detector. In mounting the latter, care should be taken not to scrape the crystals against each other, as the sensitivity of the detector may be impaired. The

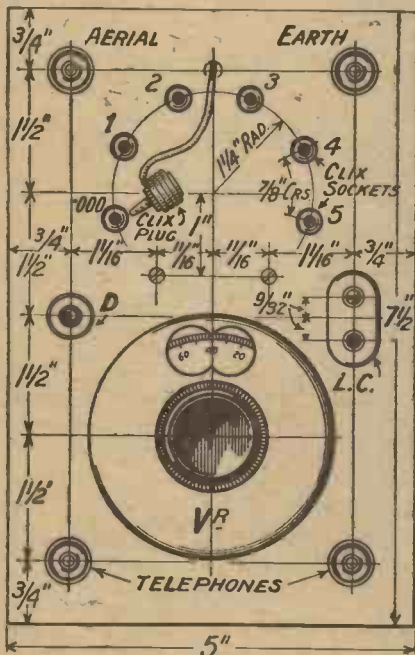

Fig. 1.—All drilling centres may be obtained from this drawing. Blueprint No. C.1055A.

nections to various studs, etc., all result in a certain amount of loss of energy. It is obvious that this is a great drawback, particularly in the case of crystal sets, where the utmost

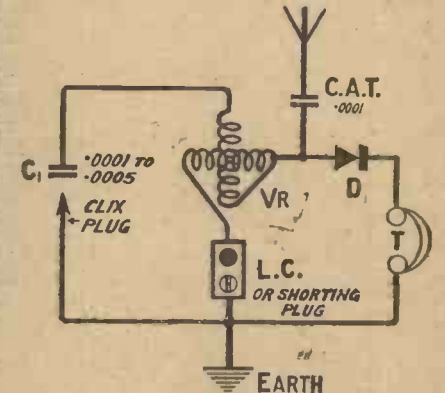

Fig. 2.—The crystal and 'phones are tapped across part of the variometer windings, while the "multiple fixed condenser" is connected across the whole variometer.

front of panel assembly is then completed by securing the five Clix sockets, as shown. The only components to be mounted from the back of the panel are the fixed multiple con-

## The "Casket" Crystal Set—continued

denser and the C.A.T. condenser. The former is screwed down in such a way that its tags make contact with the ends of the Clix sockets, as may be seen from the back-of-panel diagram. Those who wish to ensure that contact is perfect, may solder at each point, but this will not be found to be absolutely necessary if the condenser is secured firmly.

### The Wiring

The set is easily wired up, as will be seen from the back-of-panel diagram, Fig. 3, which is self-explanatory. The following notes, however, may be observed. The aerial terminal connects to one side of the C.A.T. condenser, the other side of this condenser connecting to the end of the detector which is farthest from the back of the panel, and to the lower spindle connection of the variometer. The other side of the detector connects to one of the telephone terminals, the remaining telephone terminal connecting to one side of the loading coil and thence to the earth terminal, from which a flex lead is taken as shown. The remaining side of the loading coil connects to the variometer terminal marked "earth." The variometer terminal marked "aerial" connects to the Clix socket indicated as .000. The flex lead is passed through the hole provided in the panel—the end being equipped with a Clix plug.

### Circuit

The theoretical circuit diagram,

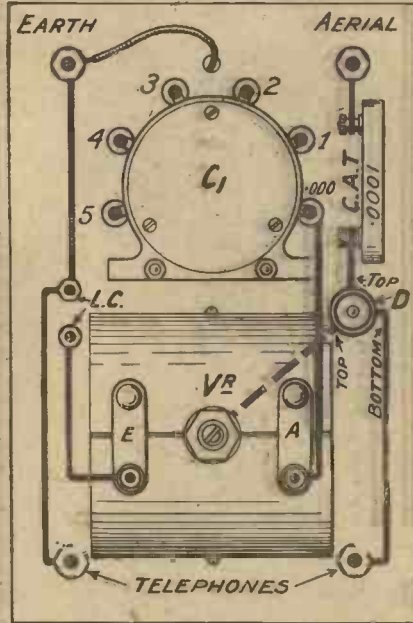

Fig. 3.—The broken line indicates that the wire is taken beneath the variometer. Blueprint No. C.1065B.

which is very simple; is shown in Fig. 2.

### Operating the Set

The operation of this receiver is no difficult matter, and the best results possible should be obtained if the following notes are observed. First con-

nect up aerial, earth and 'phones to their respective terminals. If the local station is to be received, insert the shorting link in the loading coil plug and socket. Have the variometer dial set at zero. It should be noted that when the dial reads in this position, the rotor of the variometer should be at right angles to the stator. To tune in the local station, rotate the dial until signals are heard at their loudest, having the Clix plug in socket .0001. Next ascertain that the

### WIRING IN WORDS

All directions are given as viewing the set from beneath the panel.

Join the AERIAL terminal to one side of the fixed condenser C.A.T.

Join the other side of the fixed condenser C.A.T. to the top contact of the crystal detector and also to the bottom (centre) contact of the variometer.

Join the bottom contact of the crystal detector to one TELEPHONE terminal.

Join the other TELEPHONE terminal to one side of the LOADING COIL block, and also to the EARTH terminal.

Join the other side of the LOADING COIL block to the EARTH end of the variometer winding.

Join the AERIAL end of the variometer winding to the .000 terminal on the fixed condenser C1. If necessary, solder the six tapping points on the fixed condenser C1 to the six Clix sockets.

Attach a flexible lead, with a Clix plug on the other end, to the EARTH terminal.

detector is functioning at its best by gently re-setting. This is done by lifting the plunger knob, turning round and lightly releasing. When satisfied that the detector is in a good position, try out various values of capacity across the variometer as indicated, by removing the Clix plug to one of the other sockets. It will then soon be found which value is most suitable. For the reception of Daventry, the link is removed from the coil plug and socket, and a loading coil inserted in its place. This coil should be a number 150 or 200.

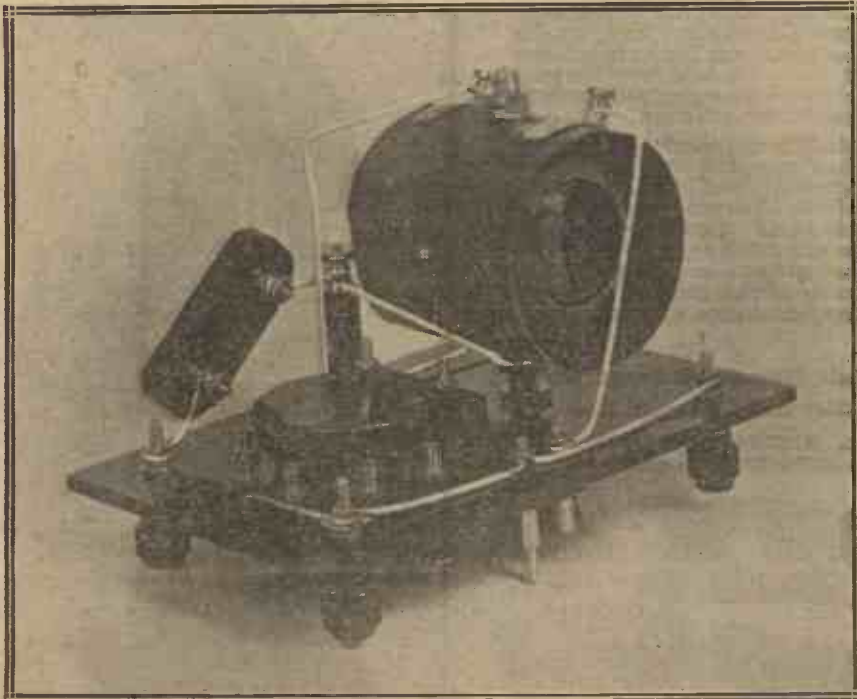

The lead to the lower spindle connection of the variometer may be clearly seen from this photograph.

## ANOTHER FREE GIFT

for OUR READERS.

The November issue of THE WIRELESS CONSTRUCTOR, published on October 15, is to be a Special Birthday Number, marking the second anniversary of the inception of this journal.

To every reader of THE WIRELESS CONSTRUCTOR a Free Gift will be presented. Every constructor will value this gift and thousands will be buying the November issue, so be sure of your copy and place an order with your newsagent now.



## Radio dips into History

**N**OW Radio — newest of all the Sciences — seeks inspiration from the Middle Ages. Just as the warrior of old was clothed in impenetrable metal to ward off the arrows and javelins of his foes, so, in this latest development of Radio, coils are being enveloped completely in metal to ward off the strong magnetic fields thrown out by adjacent coils and by other parts of the circuit.

Copex Coils finally remove the last trace of uncontrollable oscillation due to interaction. The Receiving Set becomes wonderfully stable and astonishingly selective. At a mile, and a half from 2 L.O. with the "Five Fifteen" it is possible to lose London

entirely on a degree or two of the dials and bring in other B.B.C. stations on a complete background of silence. Such amazing selectivity has only previously been possible with the Super Heterodyne — now it is brought within reach of a Set using only two H.F. stages.

Copex Coils are the original copper-shielded coils designed in collaboration with Mr. Reyner of the Radio Press Laboratories. Their six pin base permits an instant interchange of alternative coils for other wave lengths — one copper shield only is required for each stage.

Make up your mind to build one of these wonderful new Radio Press Sets now and use Copex Copper shielded coils. You will be astounded at its exceptional selectivity — at its improved stability — at its remarkable ease of operation — and, above all, at its wonderful purity of tone and complete absence of mush.

**PETO - SCOTT CO., Ltd.** (Sole Makers of Copex Coils).

Head Office & Mail Order: 77 City Rd., London, E.C. 1.

Branches: LONDON, 62, High Holborn, W.C. 1. WALTHAMSTOW, 230, Wood Street. PLYMOUTH, 4, Bank of England Place. LIVERPOOL, 4, Manchester Street.

# COPEX

## COPPER SHIELDED COILS

## Use Copex Coils in these new Radio Press Sets

### The Elstree Solodyne

("Modern Wireless," September, 1926)

Complete set of parts ...	£14 12 0
Ebonite Panel 21" x 7" x 1/4" matted and drilled ...	11 6
Polished Mahogany Cabinet with Baseboard 16" deep ...	£5 10 0

### The Mewflex Three

("Modern Wireless," September, 1926)

Complete set of parts ...	£14 0 0
Ebonite Panel 24" x 8" x 1/4" matted and drilled ...	14 6
Polished Mahogany fall-front Cabinet with Baseboard 14" deep ...	£3 3 0

### The Distaflex Two

("Wireless Constructor," October, 1926)

Complete set of parts ...	£12 1 0
Ebonite Panel 21" x 7" x 1/4" matted and drilled ...	11 6
Polished Mahogany Cabinet 21" x 7" x 14" ...	£2 15 0

\*A Marconi Royalty of 12/6 per valve holder is due when the complete kit and panel are purchased together for building this set. This Royalty must be forwarded with remittance for parts.

### Prices for Copex Shields & Coils

Copex Copper Shield (patent applied for) complete with six pin base ...	15 0
---	------

### INTERCHANGEABLE COILS.

Split Primary Type	250/550	1000/2000
	Metres.	Metres.
Aerial Coil ...	6/-	6/-
H.F. Transformer ...	10/-	10/-
Split Secondary Type		
H.F. Transformer ...	10/-	14/-
Reinartz Type Coil	10/-	14/-



### Note:

Only copper can give the perfect self-cleaning contact so essential for perfect shielding.

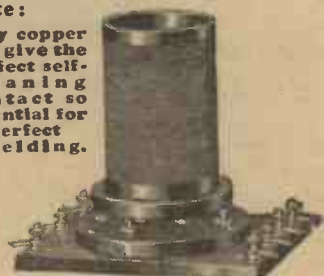

P.S. 5656

# WHICH SET SHALL I BUILD?

By C. E. M.

*What determines your choice of a set? Are you hesitating between two valves and five, and wondering which will be best? If you are uncertain how to decide, read this article. It will show you the points to consider, and will perhaps help you to choose the set which will satisfy your needs.*

EVERY month sees the publication of new receivers, which claim to be better than, or as good as, those which have gone before, and the problem of deciding upon which to build becomes increasingly difficult.

### How Many Stations?

In the first place, what really determines the choice of a receiver? What is there in one particular design which creates a desire to possess it greater than any other set? The answer in many cases is that the author's claims as to the number of stations which can be received have roused a longing to do the same thing. The deciding factor in these circumstances is the number of stations which may be received, and it is upon this point that so many people judge even the simplest sets.



one can afford should be the one to build. On the other hand, if the majority of listening to be done is concentrated upon the local station, still build a good set, but let it be one especially designed for this class of work.

### Questions of Expense

Obviously, the more popular sets are those which give a choice of programme, and in this connection only the very latest type of set should be built. This will, of course, be governed to some extent by financial ability, and for that reason a receiver should be chosen which calls for an expenditure within one's limit.

### Use Good Components

Unfortunately for some listeners, they have been misguided enough

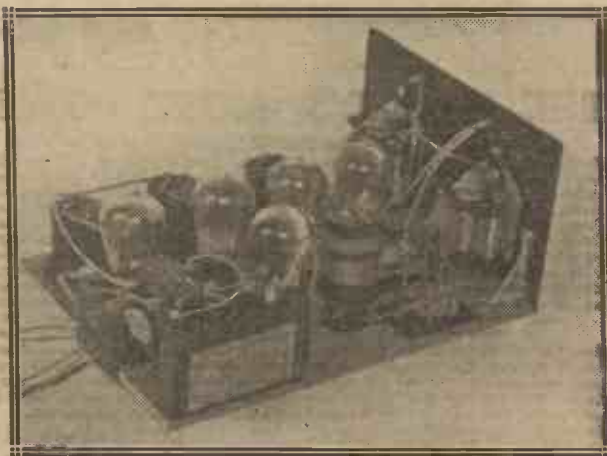
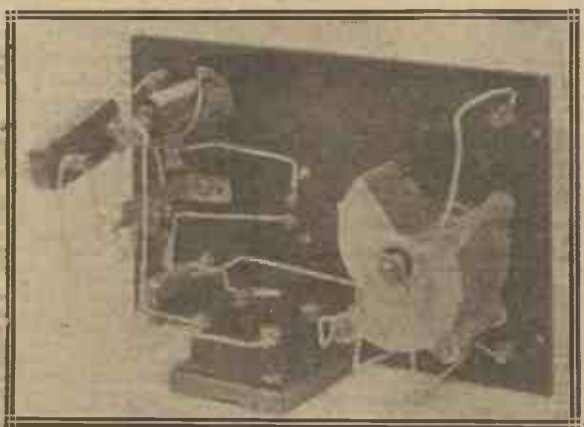

Which is it to be? Crystal, single-valve, or multi-valve set?

There is, without a doubt, a great fascination in being able to listen at will to either Hamburg, Aberdeen, Dublin, or any other station, but merely because a receiver is designed to receive the local station at really pure loud-speaker strength does not necessarily mean that this set is any less efficient or up to date than the long-range receiver.

### Volume or Distance

The two sets are not in the same class; they may, in fact, be the very

best at the moment for their own particular work. A specially-designed loud-speaker set for local work will, for instance, usually give a purer result on local work than, say, a five- or six-valve set, designed especially for distance, when receiving the same station, though generally the long-range set will be the more expensive. The decision as to which set to build should at all times, therefore, be governed by what is required of it, and in those cases where long range is required, then the very best set that

either to buy cheaper components than those specified in the construction details of the particular receiver they wish to build, or else have utilised certain components already in their possession. These latter may, of course, be suitable, but more often than not they are of different value to those specified, and the set upon completion does not give the results that were expected.

### Quality First

Rather than make mistakes of this

## Which Set Shall I Build?—continued

kind, it is better and safer to decide upon a receiver which lies within one's financial ability, even though it may use fewer valves and have a shorter range, instead of building a bigger set and trying to save money by equipping it with cheap components of unknown manufacture.

### How Many Valves?

For really efficient long-distance work a set of outstanding merit is required, and, unless a reflex circuit is employed, five or six valves will generally be used.

For satisfactory loud-speaker reception of the local station, however, the number of valves to use need not exceed four, these being a high-frequency stage, the detector, and two low-frequency stages. It is preferable that no reaction be used in the circuit, and the last valve, at any rate, should be of the power type used with a high value of H.T. and a similar value of grid bias.

### Choosing the Loud-Speaker

For either the long-range or local receiver the loud-speaker should be a good one if faithful reproduction is

desired. This does not necessarily mean that the instrument need be expensive, for there are now upon the market many really good specimens at quite reasonable prices.

### Matched Dial Readings

The set that is capable of receiving all the B.B.C. stations and all our Continental friends on the loud-speaker is unquestionably the more interesting instrument, and in these modern days need not be at all difficult to operate. The tendency today is for all the tuning dials to be matched, and so, by setting them all at zero, and proceeding round the dials one degree at a time, keeping all the dial readings the same, the operation of picking up the distant station becomes as simple as handling a set for reception of the local station only.

### Construction Simplified

The actual constructional requirements in present-day multi-valve sets are also less likely to defeat the man who has never built a receiver before, and, with the modern methods of stabilising, the chances of non-success

are distinctly remote. For these reasons the choice of, say, a single-valve set, merely because the reader has never made a set before, is a wrong road to journey, for sooner or later he is bound to be discontented with his small set, and to favour one of the larger variety, necessitating, therefore, further expenditure in components, bigger batteries, and so on.

### Avoid False Economy

A big set will do big things right from the moment of completion, but a small set can rarely be improved upon by occasional additions to the extent of doing the same things as the bigger sets. The growth from, say, one valve to many may be progressive, but with each addition it is not unusual to introduce some small defect in the general layout of the whole, which means loss of efficiency to some greater or lesser degree; particularly is this so where H.F. stages are added on the unit system.

In conclusion, the choice of a set should be determined by what is expected of it, the amount of money that one can spend, and—last, but not least—what the designer says it will do.

# Duodyne

## THE WORLD'S MOST POWERFUL LONG-DISTANCE RECEIVER

### For RANGE

Wonderful results are still being received on my "Duodyne V." Loud Speaker reception of KFI and KHJ, Radio Central KFI and HKJ The Times, Packard Building, Los Angeles, California. Other stations heard were WTAM, WJL, special test, and KGO on 'phones, also one XAD, two latter stations unknown, possibly American. W. J. McC., s.s. "Mollersnik, Finland.

Sirs,—On a voyage to the Caribbean Sea, I received Daventry daily on a large loud-speaker. Up to 900 miles signals were so loud that instrument had to be detuned. At 2,000 miles Church Service transmitted by Daventry was audible 40 ft. from loud-speaker. P.M.S. (Chief Engineer), s.s. "Rotterdam.

We have received the Duodyne V and have subjected this to a very severe test with the following results:—On three Valves (two H.F.) we can receive South African stations practically loud-speaker strength. With all five valves we can receive the British stations at full loud-speaker strength, but only intermittently, as the atmospheric disturbances are so great in this part of the world. L. D. G. M., Nairobi, Kenya.

No doubt you will be glad to hear that I have got my Duodyne 5 going. At present I can tune in Colombo, a distance of 500 miles, at full loud-speaker strength. In fact, the majority of my friends and visitors who have listened in with me have requested me to tune down as the sound was too loud. Daily I receive Colombo broadcasting concert at 800 metres wave-

**PETER CURTIS, LIMITED,**  
11, Red Lion Square, London, W.61.

Telegrams: Paracurtex, Hob., London

Telephone: Chancery 7543-4

length. Last Friday at 1.30 a.m., I tuned in a long-distance station using the 800-3000 metre Curtis Constant Tuner and heard several violin selections, pianoforte and songs by lady artists. The announcer was a gentleman, after which it appeared to be a concert given by ladies. Owing to the atmospherics, which were very bad here except at mid-day, I was not able to distinguish the station announced, but should say that it was either 5XX (Daventry) or 3 LO (Melbourne), Australia, as these are the only two stations broadcasting in English anywhere near the wavelength I covered. To say the least I am extremely satisfied with my set.

J. C. S. Kottayam,  
Travancore, S. India.

### For POWER

On a home constructed Set, using two wires, one for Aerial and one for Earth, in the same room as the Set, I have received KDKA, WBZ and several other American stations. As a Wireless Engineer, I should like to definitely state that the results with the "Duodyne" are immeasurably superior to those with any other Set I have tried.

F. S. B., St. George's Road, London, S.W.

I wish to state that the Duodyne V I bought of you is giving me every satisfaction and I am more than please with it. I get Sydney and Melbourne, Australia, on the loud speaker, which is about 1,200 miles and they come in at times as loud as local stations, and this is midsummer. I also receive Wellington (100 Watts) 200 miles away, and Dunedin (500 Watts) 250 miles, every night, just as loud as local stations.

J. P. D., Christchurch, New Zealand.

### For SELECTIVITY

I live within a mile of a relay station, and with this in full blast I can cut out and receive all the other B.B.C. stations on the loud speaker, using not more than four valves. I can receive on the loud speaker Oslo, Leipzig, Madrid, Paris Ecole, Petit Parisien, Brussels, Toulouse, Hamburg, Berlin, Rome, and many other Continental stations. W.S., Bradford.

In two hours I listened to the following (cutting out Manchester, 3 miles away): Leeds and Bradford, Sheffield, Liverpool, Stoke-on-Trent, Hull (London direct when Manchester was off), Birmingham, Aberdeen, Glasgow, two German stations, Petit Parisien, Chelmsford and Radio-Paris, without any Wave Trap. H. J. B., Manchester.



The "Duodyne" Open V. Ref. D.C.431.  
Manchester—312, DEANSGATE.

Telephone: Central 5095.

### BUILD YOUR OWN

#### Duodyne

#### THE DUODYNE TREATISE

- contains—
1. Circuit Diagrams, 3 and 5 Valve.
  2. Simplified Wiring Chart and Layout for 3 and 5 Valves.
  3. Instructions for Operation.
  4. Complete Schedule of Components.

PRICE 2/6



As used in the  
"Night Hawk"

by Mr. Percy W. Harris  
(Editor of "Wireless Constructor")  
and in other well-known  
Receiving Sets

Eleven exclusive  
Eureka features

- 1 Absolute rigidity of fixed plates ensured by unit construction.
- 2 Moving plates clamped together to permit fine spacing with absolute security.
- 3 Special method of construction eliminates the possibility of fixed and moving plates short circuiting.
- 4 Ball-bearings ensure smooth silken action under all conditions.
- 5 Dual connections (cone and pigtail) guarantee continuously silent performance.
- 6 Electrical losses so low as to be quite negligible. An invaluable feature for short-wave use.
- 7 Generous and readily accessible soldering tags.
- 8 Equipped for panel mounting as one-hole or four-hole, whichever preferred.
- 9 Positive stops at both ends of scale.
- 10 Compact design permits a panel depth when closed of less than two inches. The .0005 mfd. Ortho-cyclic takes up much less room than most .0003 mfd. condensers.
- 11 Highly polished and beautifully finished throughout—a perfect example of British craftsmanship.

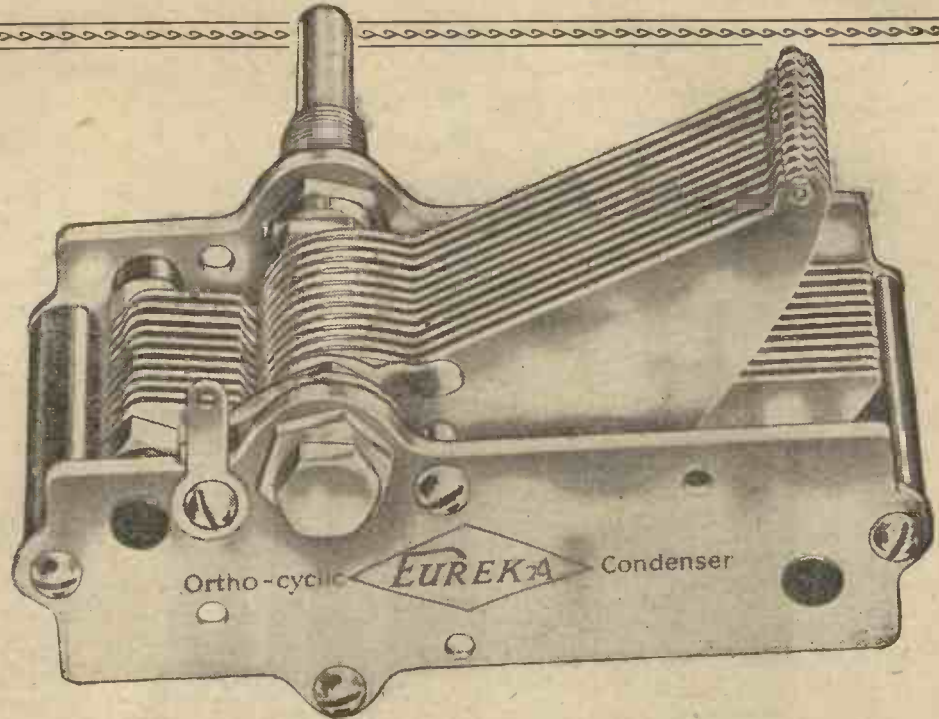

N O W !

Space out your Stations as  
evenly as the rungs of a ladder

At last there is available a British Condenser which takes out all the guesswork of station finding and ensures a standard of selectivity which is almost incredible. The new Eureka Ortho-cyclic is a fine precision-made instrument designed to give mathematically equal spacings between all wavelengths throughout the whole of the scale. Within the first 15 degrees on the dial you will find 15 wavelengths of 10 kilocycles separation. Fifteen only—one to each degree! And the same precise separation will be found all through the scale. Yet in the ordinary condenser used under the same conditions you would find 51

wavelengths crowded into the same 15 degrees. An absurd overcrowding just where you need the greatest separation to ensure workable selectivity. No wonder wave-traps and similar gadgets are necessary to separate the wanted from the unwanted stations. Add to this astounding performance a host of other electrical and mechanical features and you'll understand why the Eureka Ortho-cyclic is unrivalled for performance, uniformity and enduring dependability. Before choosing your variable condenser ask to see the Eureka. To every discriminating wireless man its beautiful workmanship will be irresistible.

Portable Utilities Co., Ltd. (Eureka Radio Products), 8 Fisher St., London, W.C.1

Prices:

.0003 mfd. 14/6  
.0005 mfd. 15/6

**EUREKA**  
ORTHO-CYCLIC

Manufactured by the  
makers of the famous  
Eureka Transformer

# Remember what Michael Angelo said?

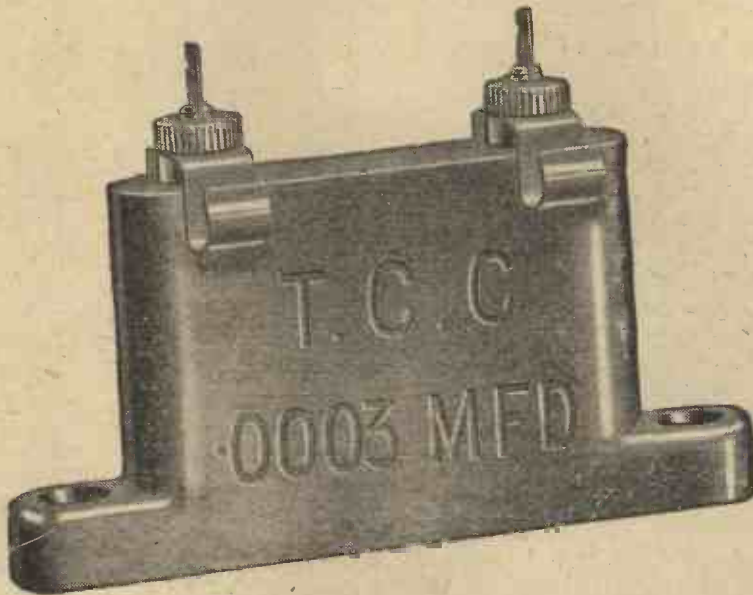

**T**RIFLES," said the famous Italian sculptor, "make perfection—but perfection is no trifle." Words of wisdom over four hundred years ago, yet particularly applicable to-day. The fixed Condenser, for instance; all know of what seeming trifles it is constructed. Just mica and copper foil. Yet between two condensers, of the same outward appearance and utilizing the same materials, there may be an immense gap—the difference between efficiency and uselessness.

Only after years of experience in Condenser manufacturing can a state of real perfection be obtained—such as the T. C. C. Mica Condenser has reached. This famous little component is the embodiment of twenty brimming years of Condenser manufacture. When you ask for the T. C. C. Mica you know you are getting a Condenser behind which are the resources of England's

Condenser pioneers. One that is constantly recommended by the foremost radio technicians of the land; one that is constructed of the finest materials available, and whose capacity is identical with that stamped on its case. Finally, you will find that the biggest bugbear in your set—condenser-leakage—is entirely absent in this, the supreme Condenser.

**Q** Prices: No. 33, all capacities between '004 and '001 mfd., 2s. 4d.; No. 34, all capacities between '009 and '0001 mfd., 2s. 4d.; from all Wireless shops

## T. C. C.

### CONDENSERS

(Mica and Mansbridge)

G.A. 566x.

## TALKS TO BEGINNERS

(Concluded from page 1070)

1925) I was able to describe a six-valve Neutrodyne receiver, using three stages of high-frequency amplification. This was known as the Anglo-American Six, and it achieved a great popularity owing to its great range and purity. This was the first popular neutrodyned multi-valve receiver built in this country.

### The Search for Efficiency

Having now reached the stage at which we could get amplification without introducing deliberate losses into the circuit, the attention of the experimenters was then turned to the fact that many of the indirect losses which had before been neglected could be removed and the efficiency still further improved. For example, the earlier high-frequency transformers of the slotted barrel type were wound with fine wire, and were of appreciable high-frequency resistance, this resistance, indeed, playing a considerable part in giving stability.

### The "Elstree Six"

With the removal of the necessity for introducing resistance, it occurred to many experimenters to see to what extent the high-frequency resistance of such transformers could be reduced, and gradually things have been improved to such a degree that the modern high-frequency transformer is a very remarkably efficient instrument. The wonderful efficiency of the now famous Elstree Six Receiver, first described in *Modern Wireless*, and now being built by thousands of home constructors throughout the country, is largely due to the very efficient coils used in making up the high-frequency transformers.

### Further Developments

The interaction problem is now being tackled in several different ways. If the magnetic field of one coil strays through the set and acts on other coils, much loss of efficiency may result, and the remarkably clever work of Mr. J. H. Reyner, B.Sc., at the Elstree Laboratories, in developing screened coils is already well known.

### "Binocular" Coils

Another method of preventing the spreading of unwanted fields is the use of "astatic" coils, such as the "binocular" type, in which, owing to the peculiar arrangement of winding the field is concentrated. Personally I have done more work on this type of coil than on shielded coils, while Mr. Reyner has specialised more on the shielded type. The "astatic" coil of the binocular type is that utilised in the Night Hawk receiver described in this issue, and is one of the reasons for the efficiency of the instrument.

**ROTAX**

# BROADCAST RECEIVERS

NEW MODELS.



## THE NEW "BABY GRAND" RECEIVER.

SINGLE SWITCH CONTROL.

ABSENCE of complicated tuning devices, handsome appearance, compactness, selectivity, and good volume with perfect reproduction of all sounds are the aspiration of both amateur and professional constructors.

Seldom, however, are all these desirable features combined in one set, but the "Baby Grand" claims them all, and to-day stands as an example of clever yet simple design with astounding flexibility and fidelity in performance. Standard finish, mahogany or oak. Height 31". Length 27". Width (front to back) 20".

Cat. No. 120. PRICE, complete with all accessories .. .. .	£25 0 0
Marconi License .. .. .	£1 17 6
Extra for H.T. accumulator if supplied in place of dry battery ..	£3 18 0

**OLYMPIA**  
STAND Nos.  
**146 & 212**

ROTAX (MOTOR ACCESSORIES) LTD.  
Rotax Works, Willesden Junction, London, N.W.10.  
'Phone: Willesden 2489. 'Grams: "Rodynalite Phone, London."

SELECTING a "Wireless Set" is a difficult matter for the individual buyer. Counter-claims by the various manufacturers tend to increase this difficulty; but these are the main essentials which should be your guide:—

1. That it is manufactured by a firm with a mature reputation for quality.
2. That the construction is sound and the design as fool-proof as possible.
3. Ease of operation.
4. Fidelity in the reproduction of both speech and music.

Come along to the Radio Exhibition at Olympia and judge Rotax Receivers on the above lines.

We are exhibiting a range of 2 and 3 valve models, including the Rotola "Baby Grand" and Portable Receivers, which are two of this season's additions to Rotax radio productions.



## "ROTOLO" PORTABLE RECEIVER.

THIS three-valve receiver, whilst being compactly self-contained, is capable of perfect radio reproduction within a thirty miles' radius of Broadcast Stations and within 100 miles of Daventry.

It is ideal for use where the erection of an aerial, etc., presents difficulties such as in flats; also for river or motoring trips and picnics, and being absolutely self-contained with aerial, valves, loud speaker, and L.T. and H.T. batteries, it can be carried from one place to another with the utmost ease, complete with valves, H.T. & L.T. batteries, loud speaker, etc.

Length 16½". Width 11". Depth 3".  
Supplied in Black or Maroon leather finish.  
Cat. No. 126. PRICE £20 0 0  
Marconi License .. .. . £1 17 6

# Cheaper and Better Jacks

Ashley Radio Jacks are made of nickel silver springs, with pure silver contact and Bakelite insulation throughout. Tags are tinned and spread fan wise for easy soldering.



BROWING HOW TAGS ARE FANNED.

Note the Prices below:



JACK No. 1. SINGLE CIRCUIT. (OPEN). 1/3

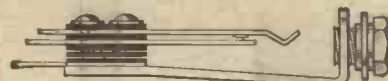

JACK No. 2. SINGLE CIRCUIT. (CLOSED). 1/6



JACK No. 3. DOUBLE CIRCUIT. 1/9



JACK No. 4. FILAMENT SINGLE CONTROL. 1/9



JACK No. 5. FILAMENT DOUBLE CONTROL. 2/3

## Telephone Plug

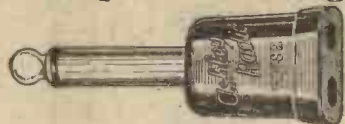

Price 1/6

Occupies less space than any other plug. Metal parts highly nickelled and polished. Bakelite insulation throughout, suitable for spade or pin tags, and any type of flexible or solid wire connection.

*Ashley Radio*

Ashley Wireless Telephone Co. (1925), Ltd.  
Finch Place, London Road, Liverpool.

# A NEW ERA IN WIRELESS RECEPTION

## RADIO PRESS STAR SETS

Standardised Designs for all Purposes

WITH the forthcoming changes in wavelengths, and particularly the arrangement of the European stations upon a "kilocycle" basis, it is fairly safe to say that a new era of reception is approaching. Interference between European broadcasting stations, hitherto so prevalent at times, will no doubt be reduced to the absolute minimum, and it will be possible to receive almost every active station in Europe at some time.

It is, therefore, only natural that new receivers should be developed, in a class of their own, of such a type that the tuning controls are reduced to a minimum, so that anyone, even if he has no previous operating experience, will be able to enjoy the advantages of these developments.

### The "Elstree Solodyne"

One such receiver is the "Elstree Solodyne," described by Mr. J. H. Reyner, B.Sc., in the September number of MODERN WIRELESS. This receiver, with only one tuning control, is capable of picking up fifty stations at loud-speaker strength. Five valves only are employed to perform this remarkable feat (two of these being high-frequency amplifiers) and the set is relatively small and compact.

It is impossible to compare a set of this nature with the "Elstree Six," since the whole character of the set is quite different. Just as one man may purchase a motor-car simply with a view to obtaining high speeds with it, whereas another may spend the same amount of money upon a much slower car, perhaps on account of better accommodation and comfort for the family, so one class of listeners will prefer the "Elstree Six" and another class the "Solodyne." Neither set is better than the other. The former may be made to give longer range and slightly greater selectivity. On the other hand, there are four controls to be manipulated, as compared with the single control of the "Solodyne." The "Elstree Six" is a set of really substantial size, whereas the "Solodyne" is small and compact.

### Star Sets

Such sets as these two and many others will in future be known as the Star Sets of the Radio Press, and the special attention of our readers will consequently be drawn to all such

receivers of very exceptional merit. Hitherto we ourselves have never attempted to differentiate between the different sets appearing in our periodicals, chiefly on account of the fact that every receiver published is put through very rigid tests at Elstree and is thus required to come up to a certain standard. In future, however, we intend to make it quite clear which are the Star sets, and these receivers will be the subject of lectures and demonstrations.

### Standard Designs

In the past a certain lack of confidence has arisen owing to the fact that certain receivers have subsequently been modified. The original S.T.100 was changed and published in an improved form, and some readers tended to "wait until they had finished fooling with the design." This will not happen in the case of the Star sets. They will remain standardised, because when they are published everything possible will have already been done with regard to the design of the receiver.

### Receivers for Everybody

Other receivers described must, however, not be looked upon as inferior, since they all do the work for which they are intended. They may not be so simple to operate, or so handsome in appearance, but the cost will, of course, be much lower. Just as a Rolls-Royce and a really good car of cheaper make are not expected to give the same performance, so, although two given sets may both be doing the job they were intended to do, one will undoubtedly be superior to the other.

### Nothing but the Best

Many of the Radio Press Star receivers will employ the screened coils developed at the Elstree Laboratories, but at the same time, for the benefit of those who wish to use something cheaper, we shall continue to supply designs which will give the reader everything he desires at a considerably lower cost.

Although the reader must naturally expect to sacrifice something by building a cheaper set, there is obviously no reason why he should not enjoy the benefit of the research work done at Elstree. The cheapest sets pub-

(Concluded on page 1104.)



EXPERTS IN RADIO ACOUSTICS SINCE 1908

SEE FOR YOURSELF....

SEE and hear for yourself. Go to a Brandes Dealer and look over the Brandes range. Get him to demonstrate, and make your own comparisons. Not many instruments of such good class are so reasonably priced. Observe that the cost of the Brandola is considerably reduced.



THE BRANDOLA

Specially built to bring greater volume with minimum current input and exceptional clarity over the full frequency range. A large diaphragm gives new rounded fullness to the low registers and

new clarified lightness to the high. Reproduction controlled by a thumb screw on the base. Polished walnut plinth with electro-plated fittings. Height 26 ins., bell 22 ins. **75/-**



THE TABLE-TALKER

The new goose-neck design is the result of research in radio acoustics, which definitely establishes its value in relation to the diaphragm fitted. Patent material used in the construction of the horn eliminates metallic harshness. Volume and

sensitivity controlled with small lever located at the rear of the base. Elegantly shaped, tasteful neutral brown finish, felt-padded base. Height 18 ins., bell 10 ins. **30/-**

**Brandes**

From any reputable Dealer.

BRANDES LIMITED · 296 REGENT ST. · W·I

64

Service Advertising

A NEW ERA IN WIRELESS RECEPTION

(concluded from page 1102)

lished will be vastly superior to older Radio Press sets, of however excellent design. We confidently expect, moreover, that they will stand far above any sets published elsewhere than in our journals.

Star Sets Already Published

Two Star sets are published in this issue, namely, the "Night Hawk" and the "Distaflex Two," full information being given for the construction of these receivers to be found elsewhere. In the September number of MODERN WIRELESS, there is the "Solodyne," already mentioned, and the "Mewflex," a three-valve reflex receiver which is of high selectivity, and is absolutely non-radiating.

"The Elstreflex"

In the issue of WIRELESS (dated September 18), which appeared yesterday (September 14), the "Elstreflex" was described. This set is a typical example of a Star set, while at the same time it is very cheap and economical. This same issue of WIRELESS also contains a Free Gift for all readers.

On another page in this issue will be found details of the Radio Press Tour, which is organised in such a way as to give an opportunity to all who are interested in the Radio Press Star Sets to see and hear them for themselves.

Which is to be Yours?

If you find that one of the Star sets suits your pocket, your requirements regarding range, selectivity or simplicity, build it at once. You will be absolutely safe in doing so, and while a six-valve set will obviously give better results than a three-valve set, you may be quite confident that you are building the best possible set in its particular class.

RADIO REVOLUTIONISED!

Read this Striking Article By JOHN SCOTT-TAGGART, F.Inst.P., A.M.I.E.E.

in the September issue of 'MODERN WIRELESS'

SPECIAL AUTUMN DOUBLE NUMBER

Now on Sale - Price 1/6



Make your  
Dream of  
Success  
Come True

Some day, you  
hope, you will  
occupy a good  
position—draw

a handsome salary or have a prosperous business of your own. You dream of the comforts, the privileges, the broad and happy life that success generally can command.

Don't forget that success has to be fought for. You have to qualify for it by making yourself more efficient, more resourceful than your fellows of the rank and file. That calls for patient effort along carefully planned lines.

Get out of the rut by taking an I.C.S. Course. It will provide you with a sound and practical training in your own home and your own time, all by correspondence and at a cost well within your means. There are no real difficulties and no heavy demands upon your time. The I.C.S. method is simple and practical. Let us tell you just how you can use it to your own great advantage.

Write to-day for full information as to how the I.C.S. can help you in your chosen vocation. There are 300 I.C.S. Courses, of which the following are the most important groups:—

The  
I. C. S.  
is the oldest  
and largest  
correspondence  
school in the  
world

**WIRELESS ENGINEERING (an entirely new Course)**

Advertising  
Architecture  
Building  
Commercial Art  
Commercial Training  
Draughtsmanship

Engineering (all  
branches)  
French and Spanish  
General Education  
Market Gardening  
Plumbing

Professional Exams.  
Salesmanship  
Showcard Writing  
Textiles  
Window Dressing  
Woodworking

**International Correspondence Schools, Ltd.**  
172, International Buildings, Kingsway, London, W.C.2

# Duo-triangular filament suspension

The New  
**SIX-SIXTY**  
Point One  
Valves!

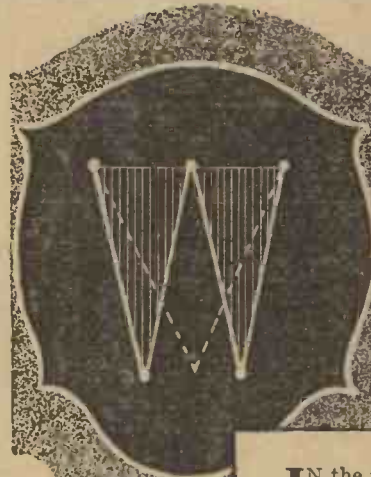

IN the record of the development of scientific valve design, DUO-TRIANGULAR FILAMENT SUSPENSION will always be hailed as "The Achievement of 1926."

The phenomenal advantages arising out of this unique, yet simple construction are amazing. To begin with, it is obvious that the length of filament employed in our new Point One Valves is almost double that in the usual type—represented by broken lines—with the result that a much greater electron emission is ensured, and further, none of this valuable electron stream is wasted since the entire filament is wholly enclosed within the grid and anode. And remember, the special Six-Sixty filament itself is wonderfully economical. Its current consumption is barely .1 amps, and when operating at the rated voltage there is absolutely no sign of "glow."

Then too, the stability and perfect alignment resulting from the additional supports render it unnecessary to assemble the filament in tension, and ensure a constancy of perfect reception. Engineers for years past have realised the stability of the Warren Girder, but it was left to Six-Sixty to apply this to the design of the radio valve.

The story of success cannot always be told in a few words. Our subsequent advertisements will reveal the structure of the perfect Valve, built on the foundation of Duo-Triangular Filament Suspension.

*Descriptive leaflet S.S.9-26 free on application*

- S.S.1. Bright Emitter General Purpose Valve 8/-
- S.S.2. H.F. D.E. H.F. and Detector 14/-
- S.S.3. H.F. & L.F. D.E. .06 amps., H.F. L.F. & Detector 14/-
- S.S.4. D.E. Power Amplifier 18/6
- S.S.5. D.E. Power Amplifier 18/6
- S.S.6. D.E. Power Amplifier 18/6
- S.S.7. D.E. .1 amp. Power Amplifier 18/6
- S.S.2A. H.F. & L.F. D.E. .1 amp. H.F. L.F. & Detector 14/-
- S.S.8. D.E. .1 amp. General Purpose 14/-
- S.S.9. D.E. .1 amp. Power Amplifier 18/6
- S.S.10. D.E. 2 volts .15 amp. Power Amplifier 18/6
- S.S.11. D.E. Power Amplifier 18/6

These prices do not apply in the Irish Free State.



Visit our Stand No. 38 at the NATIONAL RADIO EXHIBITION, OLYMPIA, September 4th—18th.

**SIX-SIXTY VALVES**  
*Better by Six Times Sixty*

THE ELECTRON CO., LTD., Triumph House, 180, Regent Street, London, W.1.

Write for  
Free List

look  
for  
it

This mark is your guarantee of good workmanship. It is a safeguard against hidden faults—an earnest of good results. It is stamped on very reliable components.

Illustration shows Vario Coupled Inductance W.G.1. fitted with special tapping switch 200/1800 metres, price 19/6. W.1. tapped inductance with six tapings 1800 metres, 15/-.

WEARITE  
COMPONENTS

Lancashire Agent:  
Alexander  
Sclanders,  
1B, Cooper Street,  
Manchester.

Glasgow Agent:  
C. G. Tideman,  
47, Carrick Street,  
C.2, Glasgow.

WRIGHT & WEAIRE, Ltd.,  
740, High Road, Tottenham, N.17.

Telephone: Tottenham 3132. Telegrams:  
Inland, "Wrightwea, Tottlane, London."  
Foreign, "Wrightwea, London."

186-4

Four of the  
**Utility**  
 GUARANTEED  
 COMPONENTS  
 that attracted special  
 attention at OLYMPIA

More than ever before, the 'Utility' Guaranteed Components attracted the attention of Wireless Enthusiasts at the recent National Radio Exhibition—sound testimony of the all-round reliability of these well-known lines.



'Utility'  
 COIL CHANGING UNITS

By means of the 'Utility' Coil Changing Unit, instant switching from one station to another can be effected. It is attached to the inside of the panel by our usual method of one hole fixing. As the illustration shows, it is only necessary to plug in coils in the ordinary way.

Price 7/6

'Utility'  
 AUTOMATIC CRYSTAL DETECTOR

Is so constructed that by slowly turning a knob, the cat's whisker is advanced and withdrawn in turn and the crystal moved round in such a way that the whole of its workable surface is explored. The very best results are therefore secured by a method requiring no skill whatever.

Prices 7/6 and 8/-



'Utility'  
 JACK & PLUG

A Jack designed on the same principles as our well-known 'Utility' Switch and similar to our Push-Pull Switch in size. Has many advantages over the ordinary type of Jack on account of its perfect rubbing contact and low self-capacity. Only one type made which will cover all needs.

Jack 4/6; Plug 3/6

'Utility'  
 LOW LOSS CONDENSERS  
 Vernier Pattern.

This famous 'Utility' Component has been improved. All brass parts are nickel plated, pigtail connection from moving plates, terminals and soldering tags are fitted, and the centre spindle rotates on ball bearings. The Vernier pattern is fitted with a Micro-Dial.

Prices from 13/-

Your local dealer stocks 'Utility' Components.  
 Ask him for the latest catalogue and particulars.



**WILKINS & WRIGHT LTD**  
 KENYON ST. **BIRMINGHAM**

**CLIX**  
 SPECIALITIES



CLIX WANDER PLUGS

These always fit perfectly, despite variations in size of sockets. They hold their leads firmly and protect them from rubbing and fraying. They make contact quickly, tightly and permanently. Nickel plated. 2d. each.



CLIX SPADE  
 TERMINALS

Especially suitable for making connections where terminals are already fitted. Prevents twisting and breaking of wire round terminal and makes a substantial large surface connection. The patented Bridge Wiring Channels and Shank Aperture present the most effective and convenient means of wire attachment ever devised. Made in red or black. Nickel plated. 2d. each.



CLIX PIN TERMINALS

An exceedingly useful pin for every purpose. By means of its length and taper connection can easily be made at points otherwise difficult. Nickel plated, red or black insulators, and patent wiring channels. 2d. each.

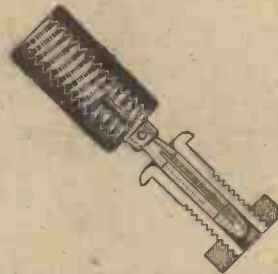

CLIX PARALLEL  
 PLUGS

CLIX PARALLEL  
 SOCKETS

Designed to combine cheapness with efficiency. Present a perfect fit for use with valve sockets and are ideal for most other purposes. Because of their resiliency they can always be relied upon to make perfect contact. Nickel plated. Plugs, 2d. Sockets, 1d.

CLIX TAPER PLUG-SOCKETS  
 CLIX TAPER ADAPTORS

Plug-Sockets 2d. ea. Adaptors 1½d. ea.  
 Insulators ½d. ea. } in Six Colours.  
 Bushes ½d. per pair }

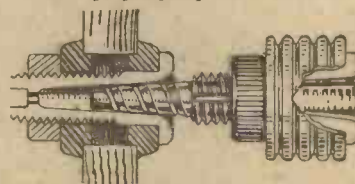

A unique connector with unlimited application. Any number of connections may be made to one point, and insulators and bushes in six colours may be obtained. Terminals eliminated and tight connections ensured. Nickel plated. 2d. each.

Clix Taper Adaptors, 1½d. each. Bushes in six colours, ½d. per pair. Insulators, ½d. each.

**AUTOVEYORS, LIMITED,**  
 84, VICTORIA STREET, WESTMINSTER, S.W.1.  
 Phone: Victoria 309. Telegrams: "Autoveyor," Sowest, London.





## WORKSHOP HINTS FOR THE HOME CONSTRUCTOR

*Mahogany—Finishing and Polishing—Makeshift  
Cabinets—Bench Drills—Tightening Loose Valve  
Pins—Making Fast Ends of Windings.*

### MAHOGANY

MANY constructors are now making use of panels of mahogany or some other hard wood to replace ebonite. Until but a few months ago a wooden panel was hardly ever seen, though there is no reason whatever why they should not be used in sets of modern design, in which the

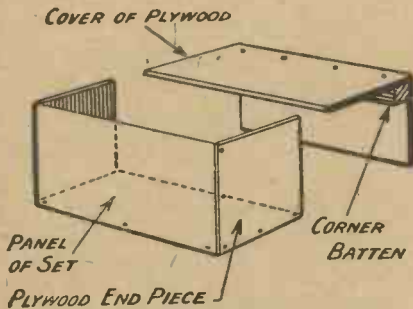

Fig. 1.—A useful temporary cabinet may be made in this way.

majority of the components are mounted upon the baseboard, the only instruments upon the panel being the variable condensers and in some cases a potentiometer and possibly one or more jacks. Since all of these can be so arranged that the metal parts which come into contact with the panel are at high-frequency earth potential, it is quite unnecessary to have expensive insulating material such as ebonite, and hard wood makes an excellent substitute.

### Wood-Working

Those who have been accustomed to working in ebonite will find hard wood a very different kind of material. To begin with, the twist drill is not suitable for making any but small holes, such as those used for the screws which fasten the panel to its side supports. To make neat, clean-cut holes for condenser bushes and the like it is best to use a brace and an auger bit. But do not run the bit right through as you would a drill when making holes in ebonite. Should you do so, you will find that it will tear its way out on the far side. As the careful constructor likes to have that part of his set which is inside

the cabinet just as neatly finished as the rest, a job of this kind will not please him. Instead of running the bit right through, proceed as follows: turn it in until the screw point comes through upon the far side; then drill from the other side, using the hole made by the point as centre. In this way you will find it easy to make perfectly clean holes with no ragged edges.

### Enlarging Holes

When it is necessary to enlarge a hole in hard wood, the best tool to use for the purpose is a "D" bit. This can be bought for about a shilling from any tool shop, and it is an all-round useful tool to add to one's equipment, since it can also be used for working ebonite. Mahogany is exceedingly tough stuff to saw and

decide to have mahogany for your panel, choose if possible a piece of rich dark colour; some mahogany is quite light in colour and this does not look nearly so well for panels. A well-marked grain will add to the beauty of the finished panel. Oak and teak should also be dark and well grained. Begin by laying the panel face upwards on the bench and rubbing it down thoroughly with the finest grade of glasspaper. This task will be made very much easier if you wrap the glasspaper round a flat piece of wood an inch or so in thickness, four or five inches long, and a couple of inches wide. Continue rubbing, not merely until all visible roughness has disappeared, but until the surface of the wood has a smooth, satiny feeling. Then give a liberal dressing with linseed oil and leave the panel



*Capt. L. F. Plugge, who is well known to our readers, started at the end of July on an extensive tour of Europe. Here he is seen leaving Dover with his wireless-equipped car.*

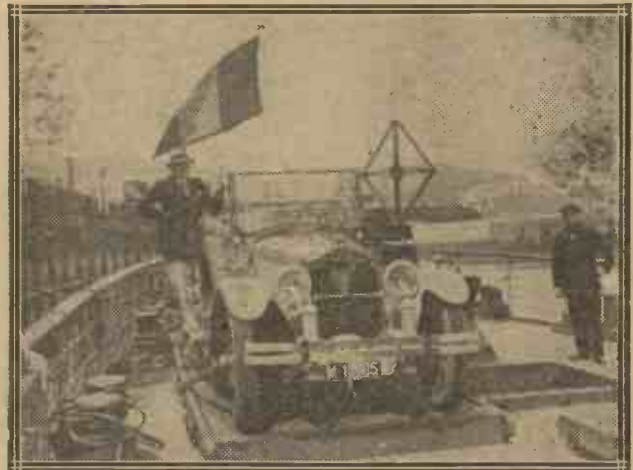
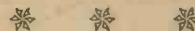

plane; the constructor will save himself a great deal of time and trouble if he purchases his panels, ready cut to size and planed up, from his local carpenter.



### FINISHING AND POLISHING

MAHOGANY and other hard woods, such as oak and teak, will take a beautiful finish, and their appearance when the set is finished will amply repay the spending of a little time and trouble over them. If you

until this has thoroughly dried. You may find when the oil has dried in that the grain of the wood has risen a little. In this case rub down again and re-dress with oil. If desired quite a high polish can now be produced by treating the panel with beeswax—and elbow grease!

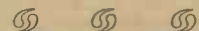

### MAKESHIFT CABINETS

IF one goes in for making up quite a number of wireless sets during the year, as many constructors do, the

## Workshop Hints—continued

cabinet problem is apt to become rather serious; many people are in fact deterred from making up big sets largely on this account. I recently

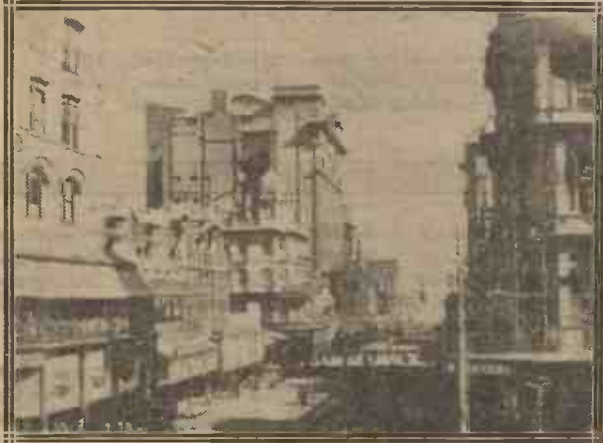

\* \* \*

*The aerial of the Johannesburg (J.B.) station is situated on a high building in the heart of the city.*

\* \* \*

hit upon a very useful scheme for making quite good-looking emergency or temporary cabinets at very small cost by a method which entails the expenditure of but little time or labour. These cabinets are exceedingly useful in a variety of ways. Sometimes, for example, it happens that you have made up a set which you do not intend to be permanent; it therefore seems hardly worth while to go to the expense of providing it with a cabinet, but if it is installed in all its nakedness in a living room, only an enthusiastic wireless man could possibly find it anything but rather an eyesore. Or, again, so much may have been spent upon the components of a large set that it is not convenient for the moment to purchase a cabinet. The emergency contrivance to be described overcomes this difficulty, since the biggest set can be decently clad in mahogany at a cost of a few shillings.

### Plywood

The temporary solution of the cabinet problem is provided by the beautiful plywoods which are obtainable very cheaply at the present time. These are made of three layers of wood, the middle one being arranged so that its grain is at right angles to that of those on the outside. For this reason plywood is immensely strong, and if we use material of reasonable thickness no trouble from warping will be experienced. The plywood I recommend is that which is used a great deal nowadays for making shop counters. It is  $\frac{3}{8}$  inch or  $\frac{1}{2}$  inch in thickness, with a layer of mahogany, teak, rosewood, oak, maple, walnut, or some other good-looking wood upon the outside. If rubbed down and oiled in the way recom-

mended for wooden panels and given a final treatment with furniture polish, plywood of this kind will take on a beautiful finish, and with it

really good emergency cabinets can be made in a ridiculously short time.

### Construction

The way in which the simplest form of plywood "cabinet" is made is shown in Fig. 1. From your local builder or joiner obtain two end pieces, each of the same height as the panel and as wide as the baseboard plus the thickness of the panel. Attach these as shown in the drawing by means of screws driven into the edges of the panel and the baseboard. The cover is made from two pieces of plywood, only one of which need have a hardwood veneer, which are fixed at right angles to one another by means of screws driven into a corner batten, as shown in the drawing. The top of

\* \* \*

*The transmissions from the Ostend Aerodrome station are probably familiar to those who listen on the longer waves.*

\* \* \*

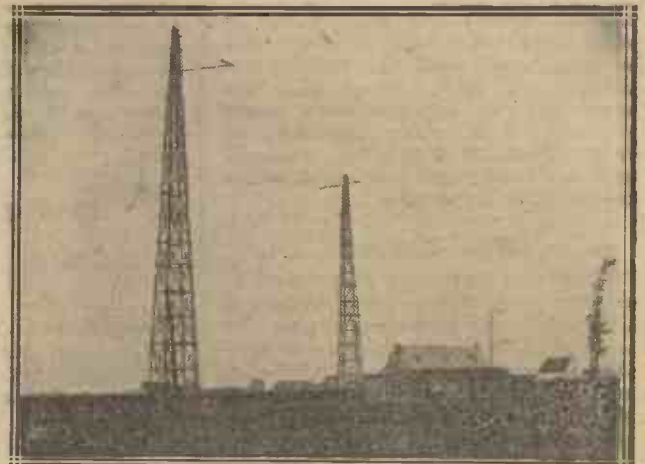

the cover should have the same width as the end pieces and should be as long as the panel plus twice the thickness of the end pieces. The back, which may be of common soft plywood, is of the same length as the cover, its height being that of the panel less

the thickness of the cover. Cuts are made in the back to allow it to fit over the terminal strips fixed to the rear edge of the baseboard. The cover simply slips on to the baseboard with its end pieces, and may be secured in place by means of swing hooks. The whole of the inner part of the set is thus immediately accessible.

A very solid appearance is given to the whole affair if the panel is provided with a mitred frame made from narrow picture moulding. When this is used, the width of the end pieces will be that of baseboard plus panel plus moulding. It should be noted that whilst these emergency cabinets give quite a good appearance to the receiving set, they in no way prevent its being put into a solid cabinet at any subsequent time: all that one has to do in this case is to remove the plywood end pieces, when the baseboard and panel can be slipped into their new cover in the ordinary way.

### BENCH DRILLS

AT this time of the year many constructors are overhauling their workshop equipment and adding to it with a view to a building campaign during the autumn and winter months. I would recommend any who contemplate the purchase of new tools to consider seriously the advisability of purchasing a bench drill, if one is not already installed in the workshop. Though the bench drill is by no means an expensive machine, it enables one to tackle a great many jobs that would be difficult, if not actually impossible, with the hand or breast drill. Bench drills suitable for wire-

less work can be purchased at prices ranging from just over £1 up to £4 or £5.

### Choosing Your Tool

In choosing a bench drill there are several rather important points to

WORKSHOP HINTS—continued

remember. The first concerns the chuck, which must be capable of taking drills up to  $\frac{3}{8}$  inch; do not, however, purchase one with a chuck much larger than this, or you may find that it is not capable of properly gripping small fine drills. See that the distance between the chuck and the table, when the former is raised to its highest position, is ample; nothing is more annoying than to find



Fig. 2.—This type of bench drill, with a lever feed, is recommended to the constructor for general use.

when you have mounted a  $\frac{3}{8}$ -inch drill that there is not room for the work and a block of wood beneath it. Next make sure that there is plenty of room between the centre of the drilling table and the body of the drill; some appliances are built on such narrow lines that you cannot make holes with them along the centre line of a 9- or 10-inch panel. A 6-inch clearance here is desirable.

Mounting the Drill

The next point to look to is the table itself, which should be heavy and solid and arranged to take a vice that can be fixed firmly in position. For wireless constructional work it is really unnecessary to have more than one speed, since one can regulate the revolutions of the drill by the rate at which one turns the crank.



Fig. 3.—A piece of wire fixed in the cleft of a valve pin will ensure a good contact with the socket.

One of the most important points of all is the system of feed. I do not like the automatic feed, which is usually either too fast or too slow for the work in hand. The hand feed would be perfectly satisfactory if one had three hands—one to turn the crank, one to hold the work, and a third to

turn down the drill! The best is, I think, the lever feed, with which one can dispense with the need of a third hand in times of emergency by hooking a suitable weight on to the lever. The drill seen in Fig. 2 is a very good type, and the constructor will find that it is of great assistance to him in doing all kinds of jobs where it is essential that holes shall be made straight.

TIGHTENING LOOSE VALVE PINS

IN not a few valves the pins are so flimsy that poor contact is made with the legs of the holder even if one has recourse to the old precaution of splaying them out at intervals with a penknife. A most useful tip is seen in Fig. 3. Take a piece of wire of No. 24 or No. 26 gauge and force its end up into the cleft between the prongs. Secure it in position by taking two or three turns round the pin. The prongs will now be forced apart and good contact is ensured, however thin they may be.

MAKING FAST ENDS OF WINDINGS.

MANY of those who make their own coils must be puzzled at times to find a way of soldering the outer end of the wire to its terminal or tag without allowing it to go slack in the

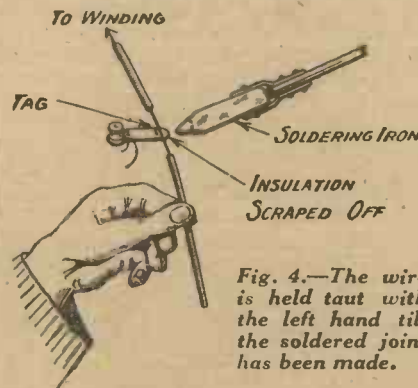
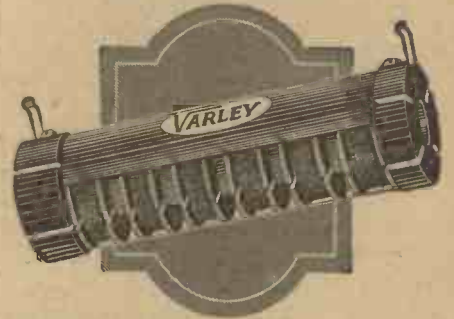

Fig. 4.—The wire is held taut with the left hand till the soldered joint has been made.

process. A very simple but most effective tip is that shown in Fig. 4. The wire is not cut short off when winding is finished, but it is kept stretched by the left hand.

Scrape away the double cotton or double silk covering until a sufficient length of wire is bare to allow soldering to the tag to be accomplished. Apply a very small amount of flux, and with a hot iron run on a small blob of solder. The tension applied by the left hand may be released as soon as the solder is cool, when the wire may be cut off short at the tag or terminal.

The Varley Multi-cellular High Frequency Choke



Chosen for the "NIGHT HAWK"

The New Varley Multi-cellular High Frequency Choke, wire wound on the famous Varley Bi-Duplex system, has already proved its efficiency by being chosen for "The Night Hawk," constructed by Mr. Percy Harris, and described in this issue of the "Wireless Constructor."

In the Varley Multi-cellular Choke, not only are the bare turns of wire silk separated, but the winding itself has its individual turns and layers air spaced in a special manner, while in addition the winding on each cell is completed before passing to the next. This method of construction reduces the self-capacity to an absolute minimum.

The complete component is built up on a multi-cellular former of highly insulating material constructed in such a way as to cut down the electrostatic capacity to an absolute minimum.

The Varley Multi-cellular H.F. Choke is perfectly constructed and beautifully finished. It is remarkably efficient, so efficient indeed that scientific experts predict vast possibilities for this new Varley product, and have no hesitation in stating that it opens up fresh fields for radio development.

PRICE 9/6

Descriptive Leaflet free on application. Visit our STAND No. 36, at the National Radio Exhibition, Olympia, September 4th to 18th.



THE VARLEY MAGNET CO. (Proprietors Oliver Pell Control Ltd.) Granville House, Arundel Street, London W.C.2. Telephone: City 3393.

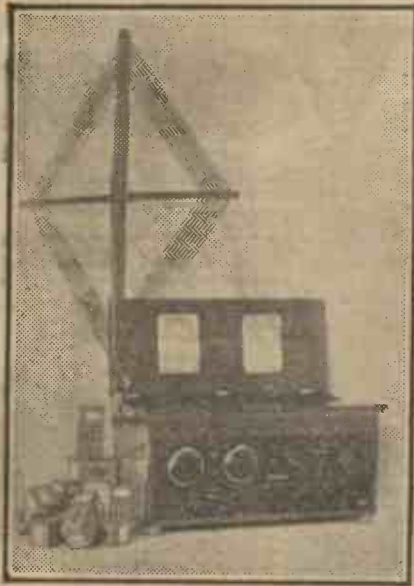

# HAVE YOU TRIED THE SUPERHET?

By JOHN UNDERDOWN

*Do you know that if you are in possession of a receiver with transformer-coupled H.F. stages of amplification, you can with little difficulty or extra expense convert it into a superheterodyne? In this article various methods of carrying out the necessary alterations are discussed, with full practical details.*

There must be, I am convinced, a very large number of experimenters who would like to enter the realm of superhet reception but who are deterred from doing so because appreciable expense is involved and probably, too, a set, which is giving perfectly satisfactory results, will be placed out of commission. Where, however, the constructor has a receiver with two or more transformer-coupled H.F. stages it is a comparatively simple and inexpensive matter to try various superhet circuits, and it is proposed in this article to outline certain methods of achieving this end.

### Utilising the Existing Set

Many readers will have sets employing Mr. Harris's well-known "Transatlantic" circuit, consisting of two tuned H.F. stages, detector, etc., plug-in transformers of barrel type being tuned by a dual condenser. Others will possess various neutralised sets, such as the "Anglo-American-6,"

involved. This is especially so in the case of "Transatlantic"-type sets, and a circuit diagram of a typical receiver of this kind is given in Fig. 1.

### Slight Alteration Necessary

Considering the theoretical details of this circuit it will be observed that there are two H.F. stages, both being tuned, a detector with reaction on to the aerial coil and a single transformer-coupled note magnifier. It will be at once apparent that the two H.F. valves can readily be used as the intermediate-frequency amplifiers of the superhet, and that it is only necessary to couple to the receiver either a combined oscillator-detector, such as the Tropadyne arrangement, or a first detector and a separate oscillator.

### The Tropadyne Arrangement

The Tropadyne arrangement, which employs a single valve to carry out the combined functions of oscillator and first detector, makes an immediate appeal from an economical standpoint, and I consider that this arrangement should give little trouble to the beginner. In fact, my first supersonic

listening arrangements being discarded since difficulty was experienced in obtaining stable working on wavelengths above 3,000 or 4,000 metres. With this receiver, working on an ordinary frame aerial, it was found possible, after dark, to obtain several of the British and Continental broadcasting stations at good loud-speaker strength, tuning being simple and the selectivity such that, at 12 miles south-east of 2LO, Manchester was obtained completely free from interference from the London station.

### Adding the Oscillator-Detector

To add an oscillator-detector, employing the Tropadyne circuit, the first step to take is slightly to alter the Fig. 1 arrangement. The two leads to the reaction coil block, shown as A and B, should be disconnected, and the plate of V3 should be taken directly to the left-hand side of C5 and T1. The L2 coil block will then serve to take the primary coil of the filter transformer L2 L1, seen in Fig. 2. The aerial coil holder, L1, then accommodates the secondary of

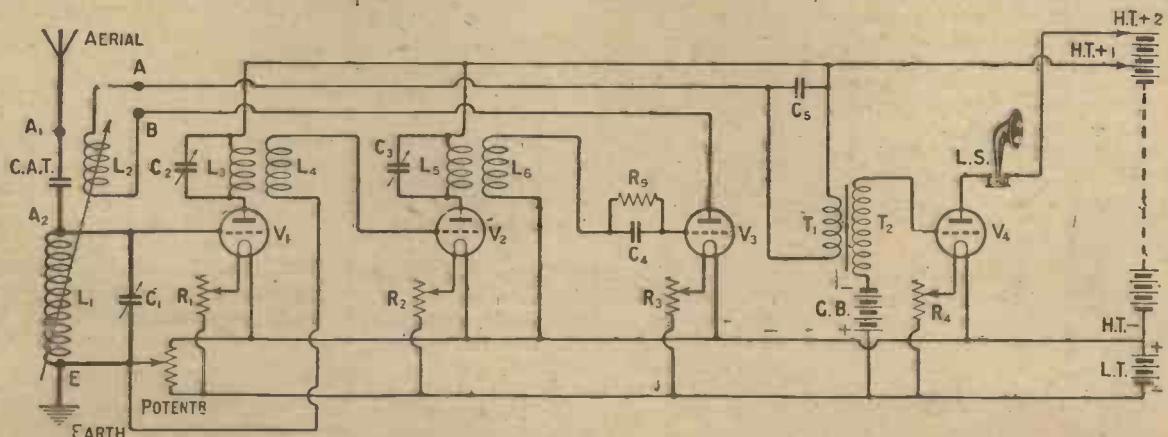

Fig. 1.—A receiver employing a circuit of this type, with tuned H.F. stages, may readily be adapted to function as a superheterodyne.

or the "4-Valve Long-Range Neutrodyne," described by the writer in the January, 1925, issue of *Modern Wireless*. The possession of such receivers forms an admirable basis for further experiments, but little trouble being

heterodyne receiver was a 5-valve set, employing a combined oscillator-detector coupled to the "4-Valve Long-Range Neutrodyne Set," which latter was altered to utilise ordinary transformer coupling, the neutra-

the filter transformer, aerial and earth being dispensed with.

### Coil Sizes

In my original experiments L1 and L2 were Gambrell H. coils tightly

Now  
you can  
Charge your  
H.T. Accumulator  
at home!



WITH the Rectalloy Charger shown above you can keep your high tension accumulator fully charged at practically no cost from your a.c. mains. It will charge any high tension accumulator up to 90 volts. in the normal series arrangement. It takes very little current, wasteful resistance being entirely obviated. At last the big difficulty of charging high tension accumulators is solved by an

entirely new and patented method. No need to carry heavy accumulators to the charging station and wait while they are charged (and perhaps ruined). Instal a Rectalloy and leave it to do its work satisfactorily and well.

The charging rate is automatically governed so that a 20 or 90 volt H. T. Accumulator receives practically the same charge. An extremely neat charge-indicator and excess-current fuse is incorporated, making the apparatus fool-proof and trustworthy.

**47/6**  
For a.c. only, 200-250  
volts, 40-60 cycles

**RECTALLOY**  
The ideal Battery charger

Send at once for full particulars and explanatory Folder W.R. post free.

A separate charger is also available for filament lighting accumulators with **65/-** a.c. current

Rectalloy Ltd., Vulcan House, Ludgate Hill, London, E.C.4.

Gilbert Ad. 5660

# THE Newey "4 Point" Condenser

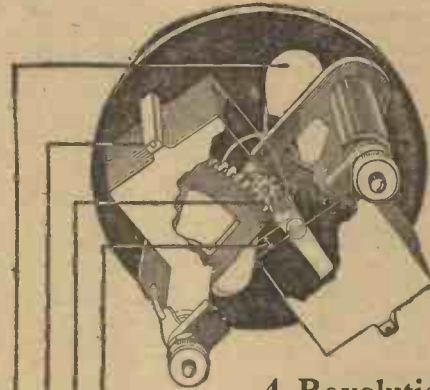

This perfectly designed and constructed Condenser works on the Square law principle, and is made by all British labour in all British Factories from the finest available material.

PRICE complete with knob and dial  
.0005 mfd. 17/6  
.0003 mfd. 15/-

## 4 Revolutionary Points

**NO HAND CAPACITY:**—The Bakelite plate on which the Condenser is mounted is specially designed to minimise self-capacity, eliminate di-electric losses, and isolate the vanes from the control knob.

**ZERO LOSS:**—All plates are bonded into a slotted equaliser bar to ensure true zero loss conditions. No rubbing contact is employed.

**360° CONTROL:**—No vernier is necessary since the condenser drive is calibrated over a range of 360°.

**MINIMUM CAPACITY NEGLIGIBLE:**—The lowest capacity position gives only .00003 mfd., as certified by the National Physical Laboratory.

## The Newey Vernier Coil Holder

A perfectly constructed coil holder, designed for Back of Panel One-Hole fixing, and in addition provided with lugs for fixing in any position on panel. Bakelite moulding throughout. Worm geared by means of metal segment and worm, and fitted with patent stop plate to prevent overwinding in extreme positions—gearing ratio 8:1 giving fine critical tuning, and permitting the use of the heaviest coil. **PRICE 7/6**

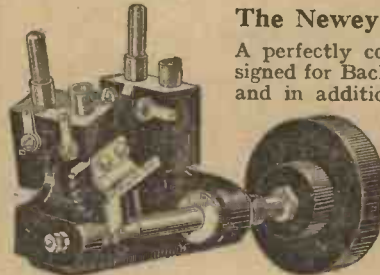

## Newey Snap Terminals.

The terminal with 1,000 uses.  
1d. each Brass. 1½d. each Nickel Plated.  
Complete sets in boxes:  
Brass, 1/6 per box. Nickel Plated, 2/- per box.  
Ask your nearest dealer for the Newey Catalogue of Radio Components. If you have any difficulty, write direct. Sole Distributors:  
**PETTIGREW & MERRIMAN (1925), Ltd.;**  
Phonos House,  
2 & 4, Bucknall Street, New Oxford Street,  
LONDON, W.1 (and Branches).  
Telephone: Merrigrew, Westcent, London.  
Telegrams:

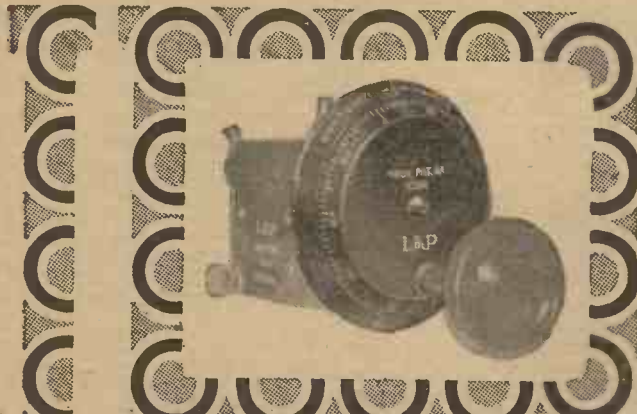
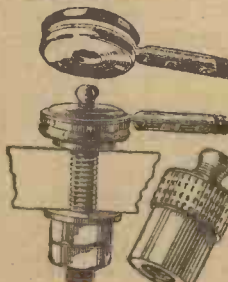

## The L & P Indicating Dial

The whole wireless world knows that the "L & P" Universal Coil Holder gives the finest control of coupling ever achieved. Thanks to the new L & P Indicating Dial you can now keep a record of the exact degree of coupling between the two coils, from 0 to 90°.

The dial is easily fitted to any L & P Coil Holder—without even the need of drilling a hole. It is an accurate scientific instrument, beautifully made, and working without a trace of backlash. The one thing needed by the experimenter who believes in keeping a log of all stations received.

**L & P Indicating Dial** - - - 5/6 each  
The L & P Universal two-coil holder is a marvel of value at 8s. 6d.

FROM GOOD DEALERS EVERYWHERE.  
Manufacturers:  
**LONDON & PROVINCIAL RADIO CO. LTD.,**  
COLNE, LANCS.  
Telephone: 94. Telegrams: "Reception."





## NEUTROVERNIA CONDENSERS

The Gambrell Neutrovernica Condenser is far and away the best for use in Neutrodyne Circuits for Neutralising or Reaction Control.

Capacity range approximately 2/38 micro microfarads.

CONSTANT CAPACITY change for each revolution of the knob, i.e., approximately 6 micro microfarads. WILL NOT SHORT. Price 5/6.

Write for special leaflet on above.

## GAMBRELL CENTRE TAPPED COILS.

These retain all the low-loss features embodied in the famous Gambrell design. They can be plugged into any standard coil socket. Are readily interchangeable. Baseboard space occupied is very small compared with other types. They are universal coils, their use not being limited to centre tapped circuits.

SIZE.	PRICE.	Approx. No. of TURNS.	SIZE.	PRICE.	Approx. No. of TURNS.
Prov. Pat. No. 25126/25.	a/2	4/10 18	D	6/3	100
	A	4/10 25	E1	6/9	150
	B1	5/- 30	E	7/9	200
	B	5/3 40	F	8/6	300
	C	5/6 50	G	10/-	500
		5/9 75			

STAND  
NINETY  
AT  
OLYMPIA.

Above prices are for the standard Gambrell Coils. Centre tapped coils 6d. extra.

Write for particulars, etc., to—

GAMBRELL BROS., LTD.,  
76, Victoria St., LONDON, S.W.1.

PARR'S AD.



## Two windings

Made specially for both dull or bright emitter valves. One winding has resistance of 6 ohms with continuation on to a 30 ohm strip winding. Resistance wire wound on hard fibre strip under great tension and immune from damage. One-hole fixing, terminals conveniently placed. Contact arm has smooth silky action. All metal parts nickel-plated. Complete with Ebonite Knob and Dial ... .. 3/9

3/9

"PEERLESS"  
DUAL  
RHEOSTAT

From all dealers or direct from  
THE BEDFORD ELECTRICAL &  
RADIO COMPANY, LIMITED,  
22, Campbell Road, Bedford.

## Do not compromise with Quality! buy HYDRA CONDENSERS

The Condensers which are selling at the rate of a quarter of a million a month in the U.S.A.

All tested on 500 volts.



Capacity	Dir. Cat. ea.	Alt. Cat. USA.
From '00011-'0011 mfd.	1/6	—
'016 up to '10	1/9	—
'10	1/9	2/-
'25 and '50	2/3	2/6
1	2/9	3/3
2	3/9	4/3
3	4/5	5/6
4	6/-	7/-

Obtainable from your dealer or direct from—  
LOUIS HOLZMAN,  
109, Kingsway, London, W.C.2

## A Good Set Deserves a GOOD PANEL

Many constructors are discriminating in their choice of components, yet do not consider the losses which result through a leaky panel.

# PARAGON PANELS

are Guaranteed Genuine Ebonite and Leak-proof. They are Easy to Drill.

YOUR LOCAL DEALER WILL SUPPLY YOU.

Write for particulars of our renowned  
ONE PIECE MICA FIXED CONDENSERS.

THE PARAGON RUBBER MANUFACTURING Co., Ltd.,  
86, GRAY'S INN ROAD, LONDON, W.C.1.

Telephone: Holborn 1856.



**FORMO**  
ARTHUR PRELUD & CO. LTD.

A MONUMENT IN THE MARCH OF PROGRESS.  
The FORMO SHROUDED Transformer is the universal favourite.  
**10/6** Made in Ratios 1-1, 1-2, 1-3, 1-4 & 1-5  
1-3 & 1-5 for 1st & 2nd Stages.  
SEND FOR CATALOGUE AND DESCRIPTIVE LITERATURE OF COMPLETE FORMO RANGE.  
THE FORMO COMPANY,  
CROWN WORKS, CRICKLEWOOD, N.W.2  
Phone: Hamp. 1787.  
Manchester: Mr. J. B. Leves, 23, Hartley St., Levenshulme. Phone: Heaton Moor, 475.  
See page 1122 for Formo S.L.F. Condenser.

**CATALOGUE**

# FREE!

A 20-page catalogue showing our latest range of cabinets and the new reduced prices. Also prices for supplying and engraving panels, etc. Invaluable as a reference. Send for a FREE copy.

**CARRINGTON MFG. Co., Ltd.**  
18/20, Norman's Buildings, Central St., London, E.C.1  
Trade enquiries invited.

CABINETS PANELS DRILLING ENGRAVING

## Have You Tried the Superhet?—continued

coupled, and the by-pass condenser C9 was of .0003 capacity. In the two H.F. transformer sockets, L3 L4 and L5 L6, two barrel-type H.F. plug-in transformers of the 2,500-7,000-metre range were utilised. My original oscillator coupler will be seen in one of the photographs, a very crude arrangement being employed here, consisting of two coils of 24 D.C.O. wire wound on an old piece of cardboard tubing  $3\frac{1}{4}$  in. diameter. The grid coil of the oscillator, O1 in Fig. 2, consisted of 49 turns, the tapping X being taken at the centre turn. The plate coil, which is wound on in the same direction and is started at  $\frac{3}{4}$  in. from the upper end of the grid coil, consisted of 30 turns.

### The Connections

The lower end or beginning of the oscillator coil O1 is connected to the

anode resistance of 100,000 ohms, this value giving an increase in signal strength and overcoming the tendency of the oscillator to squeal on the lower settings of the oscillator condenser.

### A Simple Matter

From the foregoing remarks it will be seen that it is a very simple matter to alter certain existing sets to try a simple superhet circuit, and the only extra components required are those indicated to the left-hand side of the dotted lines in the figures. Assuming, therefore, that an oscillator coupler has been wound, a frame is available, and that in the L2 and L1 coil holders suitable coils, such as Gambrell H. coils or their equivalent in other makes, namely, Nos. 300 or 400, and the longer wave H.F. transformers are available, the procedure to adopt in tuning is as follows:—

suitably set towards the negative end. Midway between these two clicks, which in certain cases may appear to

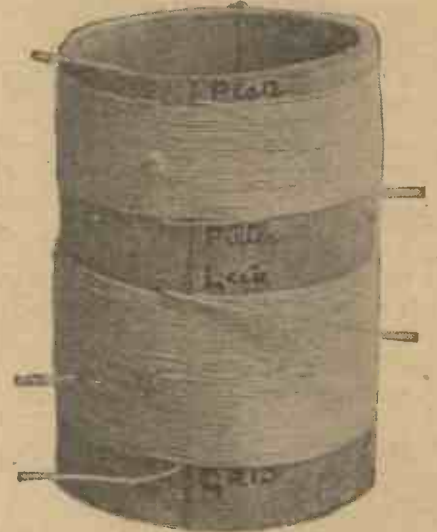

The original oscillator coupler employed by the author. The grid coil with its centre tapping is the lower winding on the former.

be merged into one, the circuits of the long-wave side are in tune. An idea is thus obtained as to the divergence of readings between the C1 condenser and the dual condenser or the two condensers C2, C3.

### Not Critical

The tuning on the long-wave side will be by no means critical, and this part of the receiver may be left adjusted as mentioned above, oscillation being checked by means of the potentiometer. The next steps to take are

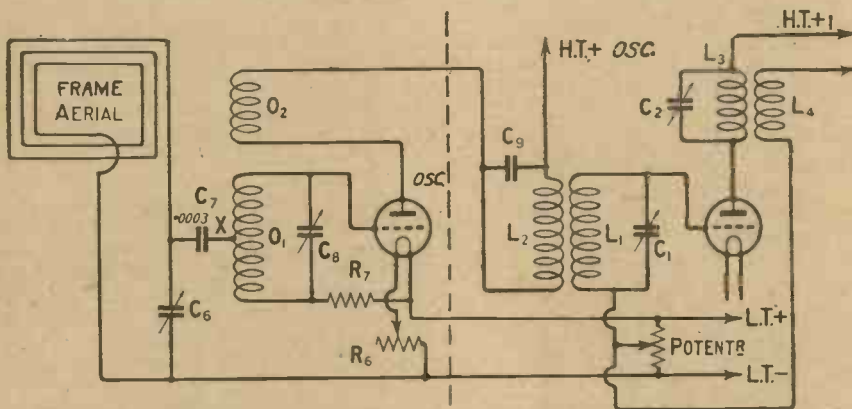

Fig. 2.—An oscillator-detector valve, employing the Tropadyne system, may be connected to the Fig. 1 circuit as shown here.

grid of the oscillator valve, the centre tapping goes to the grid condenser C7 and the upper end of the coil goes to the gridleak R7. The beginning of the plate coil is connected to the primary coil of the filter L2 and to C9, whilst the upper end or finish of the same winding is taken to the plate of the oscillator valve. The grid coil is tuned by a parallel condenser, preferably of geared type and of .0005 capacity. The frame aerial shown in Fig. 2 may consist of 12 to 14 turns upon a frame with 3-ft. sides, the turns being spaced  $\frac{1}{4}$  in. The frame condenser C6 should be of .0005 capacity.

### The Gridleak

The gridleak, R7, of the combined oscillator-detector has considerable bearing upon the functioning of this valve, and here in my early experiments I found one of really high resistance, for example, 10 to 15 megohms, to be preferred. A .06 ampere valve, actually a Radio-Micro, was then used. From later experiments, however, using modern valves of the high-impedance type, I have found it better to employ an

Adjust the H.F. tuning condensers or dual condenser C2 C3 to some intermediate value, say 50 degrees, and,

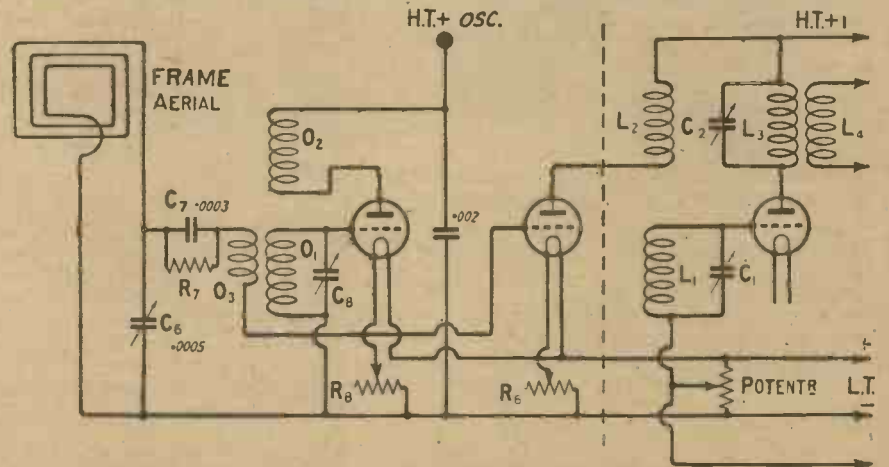

Fig. 3.—Here are given the necessary connections for adapting the receiver to use a separate oscillator valve.

with the oscillator valve extinguished, rotate C1, when clicks will be heard as the set goes into and out of oscillation, the potentiometer slider being

to switch into circuit the combined oscillator-detector valve by means of its filament rheostat R6, employing a voltage here of the order of 70 or 80

## Have You Tried the Superhet?—continued

volts (with most valves), and to adjust the frame and oscillator condensers. Unless the tapping point X on the O1 coil is at the exact electrical centre or nodal point it will be found that when the oscillator circuit is in tune with the frame circuit the oscillator will go out of oscillation, this being announced by a click or pop. No notice should be taken of this phenomenon, for a start, since it will provide useful information as to how nearly in tune are the two circuits.

### Searching for Signals

Now, beginning with the frame condenser C6 at its minimum setting, increase this condenser reading by one or two degrees at a time whilst slowly swinging the oscillator condenser over 20 or 30 degrees on each side of the point where the click is heard. By following this sequence in tuning throughout, the local station should be heard, and when this transmission is obtained attention should be paid to the long-wave side. This latter, although approximately in tune throughout, is not necessarily tuned to the wavelength of the primary circuit of the filter L2, C9, and adjustment of the settings of C1, C2 and C3 should be carried out, in conjunction with slight adjustment of the oscillator condenser C8, until maximum signal strength is obtained, the necessary alteration of the potentiometer setting being made to keep the

a plug-in oscillator coupler which I now employ, and which was wound for me by Messrs. Peto-Scott Co., Ltd., will be seen in one of the photographs.

arrangement, allowing the nodal point of the oscillator coil O1 to be found with a greater degree of accuracy than is otherwise possible. The necessary,

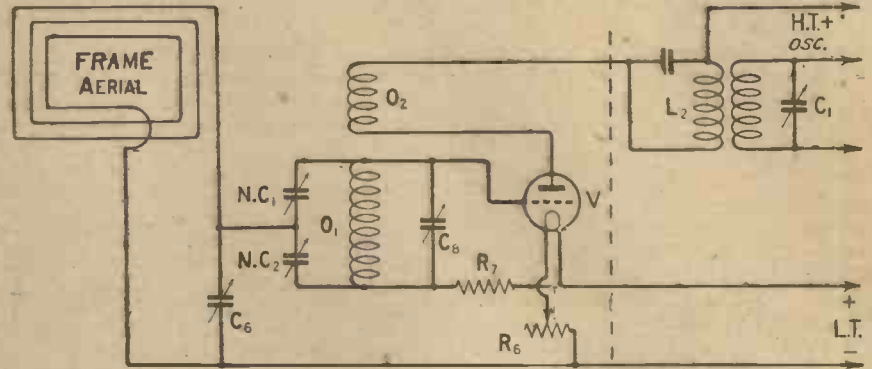

Fig. 4.—By means of the two small condensers N.C1 and N.C2 the nodal point on the coil O1 may readily be obtained, the Tropadyne system being in use here.

The nodal point with this latter coil is obtained by means of a balancing condenser, a similar arrangement to that of the Fig. 4 circuit being utilised.

### The Separate Oscillator Arrangement

Some constructors may prefer to try the separate oscillator arrangement and for this the necessary circuit is outlined in Fig. 3. The oscillator coils may be of the same size as pre-

connections for this modification are indicated in Fig. 4. N.C1 and N.C2, which are two neutralising condensers, should be set at maximum capacity for a start, and the effect of slightly decreasing the capacity of each in turn should be noted, when it will be found that the phenomenon of audible clicks when the oscillator circuit comes into tune with the frame circuit may be eliminated. When this occurs the neutralising condensers are adjusted to give no interaction between the two tuned circuits, but some slight benefit may ensue if this balance is slightly upset, as a reaction effect, useful when receiving distant stations, is thus introduced.

### Values

Throughout the diagrams uniformity in lettering components has been observed, and the coils, etc., of the long-wave side, indicated in the beginning of the article, will be suitable for all the circuits shown.



\* \* \*

The oscillator coupler was subsequently made up in the more compact form shown here.

\* \* \*

long-wave side away from the oscillating condition. This sounds somewhat complicated, but in practice it will be found quite easy, and an hour or two's handling of the set will allow the "feel" of it to be obtained.

### An Improved Oscillator Coupler

The oscillator coupler previously described is somewhat bulky, and a more compact component may be constructed by employing a 2-in. diameter former, in which case O1 should consist of 60 turns of 30-gauge d.s.c. wire, and O2 should be of 30 to 35 turns of the same gauge wire, spaced at 1/4 in. from O1. The connections will be as given for the larger coil. A coil of the above size, together with

viously indicated, but the pick-up coil O3 should be of 10 to 15 turns. This may be a hank-wound coil, of any suitable gauge wire, such as 24 d.c.c., arranged to slide within the tube upon which O1 and O2 are wound, the best coupling position being found by experiment. There is no need, with this arrangement, to tune the primary of the filter transformer.

### Utilising Neutralised Receivers

Where the set to be employed for the long-wave side, etc., of the superhet employs an earlier neutralising system, I would suggest that it be altered to ordinary H.F. transformer coupling, and that the neutralising condensers be employed in a balancing

**A POINT TO WATCH**

NOW that dull emitter valves are on the market from whose filaments no visible glow is seen when the correct low-tension current is passing, it behoves every constructor to be particularly careful to switch off the receiving set when called away from the room. Of course, the set will "speak for itself" if a loud-speaker is in use, but when telephones are being employed there is really no indication that the set is still "alive."

In the earlier days, when the incandescence of the valve filaments was plainly visible, the small valve windows had a great vogue, but with non-glowing valves extra precautions must be taken to avoid waste of battery power through leaving the set on.





Trade Mark "Nightingale." Copyright.

A PERFECT DETECTOR AT LAST! THE WONDERFUL "Nightingale" Master Crystal Detector

Trade Mark.

Patent Applied for.

EMPLOYING phosphor bronze in firm contact with "Goldite," which has been a difficult and expensive wireless crystal to produce, the N.M.C. Detector has effected a very important advance in radio rectification.

Unlike cat's-whisker and perikon arrangements, etc., "Goldite," an extremely hard crystal, is engaged with a considerable amount of pressure between two phosphor bronze contacts which cannot shift, and is not only a perfectly stable, and exceptionally efficient rectifier of radio signals, but it also affords a higher degree of tonal purity than any other detector whatsoever, which alone will contribute an improvement to the reception of any wireless receiver employing any other kind of detection.

In addition, the N.M.C. Detector has considerable distance sensitivity, definitely providing in all, thoroughly reliable, and trouble-free detection of a powerful and particularly pleasing nature, hitherto impossible by any other means to obtain.

Apart from possessing such sterling qualities as a rectifier, "Goldite" tenaciously retains its sensitivity even under the most adverse conditions, and can be handled, or exposed to any atmosphere, without injuring it in the least.

Moreover, you can procure this wonderful detector, which has no equal at any price COMPLETE FOR EASY PANEL MOUNTING at 2/6. GUARANTEED FOR FIVE YEARS.

From your dealer, or post free from N.M.C. DETECTORS, 30, Princes Parade, London, N.3. To the Trade.—If you have not already obtained supplies, please write for particulars. UTMOST TONAL PURITY—STABILITY—VOLUME. THE MOST PERFECT DETECTOR POSSIBLE TO PRODUCE. "All through the night, until the hour before the dawn, that marvellous voice shall hold the woodland spellbound."

Components of merits

Since the advent of Broadcasting our British made components have given entire satisfaction to all users. You can inspect them and buy them from your local dealers or at the Olympia Exhibition.

STAND No. 206 OLYMPIA



LO-LOSS COILS

Finston Lo-Loss Coils are designed to give maximum air spacing. Special thumb grips on base enable coils to be plugged-in or removed without fear of damage to the windings.

Efficient in action		Strong in construction.	
Prices: No. 25	... 1/3	No. 150	... 2/9
35	... 1/6	175	... 3/3
50	... 1/9	200	... 3/6
75	... 2/-	250	... 3/9
100	... 2/6	300	... 4/-

FINSTON FILAMENT RESISTANCES (on Bakelite Moulding).

Well designed and constructed. Of nice appearance, and smooth in action.		Of nice appearance, and smooth in action.	
Prices: 7 ohms	... ..	2/3	
15 or 30 ohms	... ..	2/6	
Dual, 6 and 30 ohms	... ..	3/3	



SUPER COILS

Finston Super Coils have been so constructed that the centres are always in alignment when two or more are used, thereby securing maximum results from their magnetic field.

All connections are soldered, so as to give constant electrical continuity throughout.

A loose plug is provided so that the winding of the coils can be reversed if so desired.

They are totally enclosed in moulded Bakelite cases, giving great mechanical strength without impairing their efficiency.

Prices:—25, 35, 40, 2/6 each; 50, 60, 3/- each; 75, 100, 150, 3/6 each; 175, 200, 4/- each; 250, 300, 4/6 each.

FINSTON MICRO-VERNIER DIAL.

This dial can be used with all types of variable condensers and it gives perfect control. Coarse and fine tuning.

Ratio 80 to 1. Price 6/6.

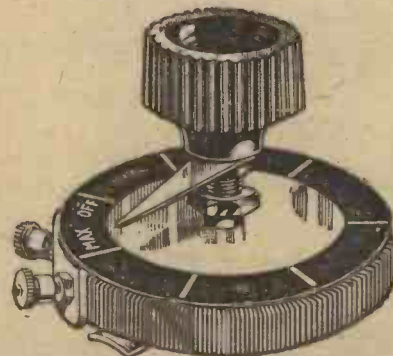

FINSTON MANUFACTURING CO., LTD., 45, Horseferry Rd., London, S.W.1.

Parr's Ad.

RESERVE YOUR SPACE EARLY!

Copy and Blocks for the November issue of THE WIRELESS CONSTRUCTOR should reach us by Sept. 20th, 1926.

Communications to the Advertisement Manager, THE WIRELESS CONSTRUCTOR, Bush House, Strand W.C.2.

THE "SFERAVOX" LOUD SPEAKER

IS THE BEST ON THE MARKET.

Obtainable from all Stockists, Dealers and Stores.

Read the remarkable Press Notices printed below—these speak volumes for the "SFERAVOX" and are the unbiased opinions of these well-known Publications.

POPULAR WIRELESS—APPARATUS TESTED: The sensitivity of the instrument is of an extraordinary high degree, both speech and music came with most satisfactory purity. Rattling and buzzing were not apparent in the SFERAVOX, and the almost imperceptible existing "periods" were discovered at most comfortable points.

AMATEUR WIRELESS—APPARATUS WE HAVE TESTED: The volume obtainable equals the horn types, whilst the tonal quality is remarkably pure. On the lower audible frequencies response is very high and very even.

TOWN & COUNTRY HOMES: The SFERAVOX is a new departure and gives the three essentials, which are purity of tone, sensitivity and volume. It is a distinct improvement on the disc Loudspeaker class.

WIRELESS WEEKLY: Its sensitivity is remarkable, while the roundness of tone, and its response to high and low tones are superior.



£2 : 10 : 0

"SFERAVOX," 130, Fenchurch Street, LONDON, E.C.

Phone: Avenue 2481 (2 lines).

Graham Services

# A SIMPLE VARIABLE CONDENSER

A SIMPLE variable condenser may be made from the tin-foil discs such as are to be found with any type of air-tight two-ounce tobacco tin. All that are required are the discs from two such tins, a piece of ebonite, some cardboard, paper, 6BA rod, two 6BA screws, one ebonite knob bush 6BA, three 6BA nuts, and one 6BA terminal head. The diagram shows clearly the constructional details of this useful component, which takes up very little space in a receiver.

### Construction of Fixed Element

If the device is built into the receiver, it will be necessary to drill three 6BA tapped holes, as shown. Disc A represents one of the circular tin foils with a clearing hole cut in the centre. Disc B represents a thin cardboard disc of similar size, also with a clearing hole in the centre. These two discs are secured to the panel, as shown, by means of the two 6BA screws.

### The Moving Element

For the moving element, three discs will be required. Disc C represents

a thin cardboard disc of small diameter, having a central hole to clear 6BA. Disc D represents the remaining circular tin foil cut to a

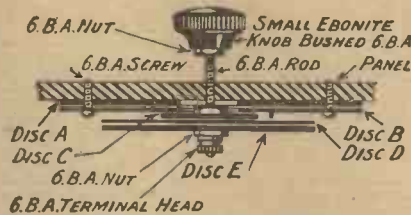

Fig. 1.—If a quicker adjustment is desired, a spindle of larger diameter than 6BA may be used.

somewhat smaller diameter, also with a 6BA clearing hole in the centre. Disc E represents a stout cardboard disc with a central 6BA clearing hole. All three discs are clamped together upon a short length of 6BA rod, as shown, by means of 6BA nuts. This is then assembled to the panel by screwing the projecting portion of the 6BA rod through the panel from the underside, and finally equipping the end with the bushed ebonite knob and locknut.

### Connections

Connections from the variable condenser to the receiver are made by taking one lead from one of the 6BA panel screws between disc A and disc B. The moving connection, which should be made with flexible wire, is taken from between the 6BA terminal head and nut.

### Operation

To use the condenser, it is only necessary to rotate the ebonite knob, thus decreasing or increasing, as the case may be, the distance between the two tin-foil discs. Very fine adjustments may be made with a condenser of this type, ranging from practically zero to .0005 microfarads approximately, in addition to which it is of small size, its contacts are certain, and its construction is cheap and efficient.

H. B.

Have You Had Your Copy of the September SPECIAL AUTUMN DOUBLE NUMBER of 'MODERN WIRELESS' Now on Sale - Price 1/6

## ASK YOUR DEALER

for the new



# S. L. F.

The New J.B., S.L.F. Condenser is made on lines similar to our Low Loss Type (Pat. No. 241805). In addition, its many excellent new features include Special Bearings Top and Bottom which eliminate springs. Side and End play in the centre spindle is impossible. The Top Bearing is of large diameter and friction-lined, which ensures an absolutely smooth movement. The brass vanes are supported at tips to ensure accurate spacing. End plates are highly polished and all fittings are heavily nickel-plated.

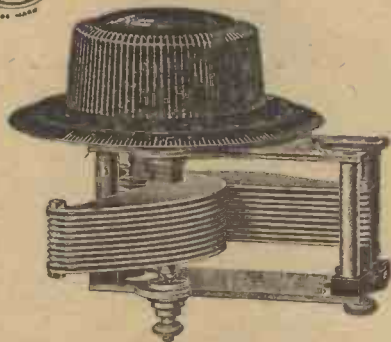

Fitted with 3/8" shaft, sold complete with 4" Dial and is more compact than most S.L.F. Condensers.

	Retail Prices:
.0005 mfd	.. .. 11/6
.00035 mfd	.. .. 10/6
.00025 mfd	.. .. 10/-

SEE US ON STAND No. 235.

# JACKSON BROS.

8, POLAND ST- OXFORD ST  
LONDON - W.1  
(First Floor)

Telephone: GEF. RARD 7414

Agents for Holland: Radio Beurs, Papstraat 8, Sgavenhage, Hague, Holland

## Come and See the best Coil Holders!

At Stand No. 84 at the National Radio Exhibition you are invited to inspect for yourself the Coil Holders that are used in fully half the sets that are made—the "Lotus" Coil Holders. Their popularity with constructors everywhere is due to their unvarying good performance and the following unique features:—

**Moving Block cannot fall**  
Moves in same direction as knob, thus preventing confusion. Holds heaviest coil securely in any position. Dead accurate tuning possible because encased precision cut gears reduce speed by 8 to 1.

From all Radio Dealers

# LOTUS

VERNIER  
COIL HOLDERS

GARNETT, WHITELEY & CO., Ltd.  
Lotus Works, Broadgreen Road,  
LIVERPOOL.

Makers of the new Lotus Buoyancy Valve Holder.

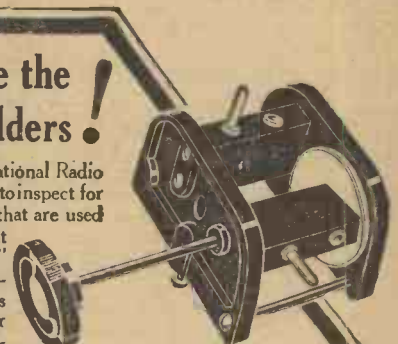

TWO TYPES:  
For outside panel mounting  
Two-way - 7/-  
Three-way - 10/6  
For inside base-board mounting with 6-in. handle  
Two-way - 8/-  
Three-way - 13/6

Bakelite mouldings for the side plates, coil blocks and knobs: heavy nickel plating for the metal parts.

# Special Wireless Cabinets to Customer's orders

Cabinets that at any time are illustrated or described by the Editor of this Journal we can make to order. Ask for prices. Delivered free anywhere in the United Kingdom.

Hundreds of readers of this Journal have expressed their satisfaction with workmanship and price of our cabinets

Specialist makers of Wireless Cabinets  
Caxton Wood Turnery Co.  
Market Harborough

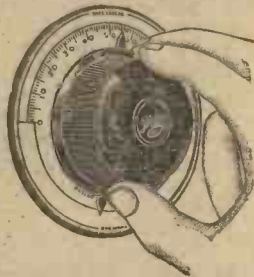

## "DIALOG"

### THE IDEAL VERNIER CONTROL

The "Dialog" is specially designed to give smooth accurate tuning without undue waste of time. It is constructed upon an entirely new principle and will give you the results you have always desired—quick and easy separation of stations, NO BACKLASH and provision is made upon the dial plate, which also serves as a hand capacity shield, for logging stations and wave-lengths.

**FITS ANY SET. No drilling required.**

The "Dialog" is one hole fixing and can be attached to most condensers in one minute with only the use of a screw-driver.

**GUARANTEE.**—There is nothing in the "Dialog" to wear out, and it is unconditionally guaranteed.

**TYPES:**

Black Bakelite Knob with Silvered Dial	} Price
Black Bakelite Knob with Black Dial	
Brown Bakelite Knob with Gilded Dial	

**7/6 each.**

Dials graduated 0-100 either clockwise or anti-clockwise or full 360 degree scale.

**THE STANDARD INSULATOR CO., LTD.,**  
Winsley House, Wells Street, Oxford Street, LONDON, W.1

Phone Nos.: Museum 5978. 7577. Telegraphic Address: "Hivoltst" Weso, London.

## For the "Night Hawk"

use **KEYSTONE** Fieldless Coils

Fitted with the new Radio Press Standard Six-Pin Base. Available for the B.B.C. and Daventry wave lengths.

Price per Coil..... 10/6

(3 Coils are required for each wave length range)

Six-Pin Bases, each..... 3/6



### KEYSTONE NEUTRALISING CONDENSERS.

Selected for use in the Night Hawk, the Elstree Six and the Elstree Solodyne.

The minimum capacity of this condenser has been approved by Radio Press Ltd. Beware of imitations which may not be of correct capacity.

Panel Mounting ... 6/3

Board Mounting ... 5/-

N.B.—For the Night Hawk set, please ask for the 9-plate model, specially made for this receiver.

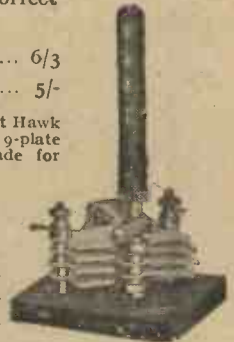

All the parts for this month's sets.

We can supply all the parts for all sets described in Radio Press Journals, and we offer free technical service to all customers. Send for the PILOT MANUAL (post free 6d.) which gives full details of our unique scheme for home construction, and illustrated details of over twenty sets.

### THE NIGHT HAWK

Complete Set of Parts ...	£11 8 6
Ebonite Panel, 16 x 8 x 1/8 matted and drilled ...	8 6
Polished Mahogany Cabinet, with 1 1/4 in. baseboard ...	3 0 0
Finished Instrument, aerial tested ...	19 17 0
Marconi Royalties extra ...	3 2 6

### THE DISTAFLEX TWO.

Complete Set of Parts ...	£12 1 0
Ebonite Panel 21 x 7 x 1/8 matted and drilled ...	11 6
Polished Mahogany Cabinet 21 x 7 x 1 1/4 ...	2 15 0
Finished Instrument, aerial tested ...	20 7 6
Marconi Royalties extra ...	1 5 0

Any part or parts supplied separately. Detailed lists on application. If a complete set of parts is ordered, Marconi Royalties at the rate of 12/6 per valve holder must be remitted with order.

**PETO-SCOTT Co., Ltd., 77, City Road, E.C.1.**

Branches: 62, High Holborn, London, W.C.1. WALTHAMSTOW—230, Wood St. PLYMOUTH—Bank of England Place. LIVERPOOL—4, Manchester St.

P.S. 5656

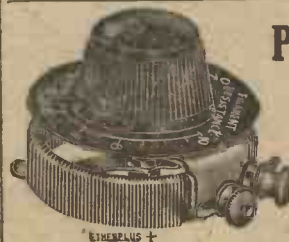

## PERFECT CONTACT

—the outstanding quality of the new Etherplus V.C. Rheostat

Neat attractive pointer knob fits flush with engraved dial over one hole fixing nut.

Price.  
6 ohms  
30 ohms  
15 ohms

**2/3 each.**

From dealers or from

**M. & A. WOLFF.**  
9-15, Whitecross St., London, E.C.1



RADIO ACCESSORIES  
= ENSURE PERFECT RECEPTION

EXPERTS IN RADIO ACOUSTICS SINCE 1908

## TWO NEW CONE SPEAKERS

THE Ellipticon has been described as "the best loudspeaker on the market" by one who is fully qualified to judge, and who has no personal interest in our success. And we honestly consider that it is one of the best instruments we have ever turned out. The Tablecone, too, can really be said to be superior to similarly priced Cones.



### THE ELLIPTICON

(Registered Trade Mark)

The new Brandes Cone. Undoubtedly the best loudspeaker produced, it brings tone of great depth and sweetness. The cone has a large vibrating area and a driving unit of special design. The magnets in the unit are unusually large. There is no diaphragm but a small arma-

ture which, actuated on the "push-pull" principle, reacts to the faintest impulse. The specially designed cabinet "reflects" the sound in rich and mellowed tones.

Height ..	13 1/2 ins.	£5 10
Depth ..	7 1/2 ins.	
Width ..	10 1/2 ins.	

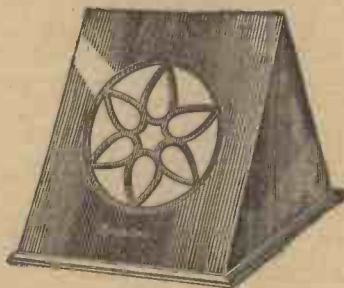

### THE TABLECONE

Attractive cabinet of unique design, finished in dark walnut. The cone unit is fitted with a large magnet and the circular diaphragm has an extremely sensitive driving unit which provides plenty of volume with unblemished tone.

Supplied complete with cord connection. It has a genuine claim to be superior to any similarly priced cone speaker.

Height ..	10 ins.	£2 15
Depth (at base) ..	11 1/2 ins.	
Breadth ..	9 1/2 ins.	

# Brandes

From any reputable Dealer.

BRANDES LIMITED • 296 REGENT ST. • W.1

62

Service Advertising

## THE "DISTAFLEX TWO"

(Concluded from page 1062)

Until this skill is obtained, it is simply necessary to insert the telephones in jack No. 2 or jack No. 1 if preferred, and tune the stations in. On removing the plug the signals will be put through on to the loud-speaker terminals on the back of the set. It may possibly be necessary to retune the last circuit slightly, but this is a matter which will easily be found out in practice.

### Choice of Transformers

A word of warning may be given concerning the transformers. The actual make of transformer is not too critical provided a high-quality component is used. It is essential, however, that the secondary winding of the transformer shall have a low self-capacity, since this winding acts as a choke to any high-frequency parasitic oscillations which may tend to be produced in the circuit.

The use of the transformers specified is therefore to be recommended, but those readers who already possess transformers which they wish to use can do so in certain cases. A list of suitable alternative transformers which have actually been tried in the receiver will be published next month.

### Note this Carefully

Under no circumstances whatever must a condenser be connected across the secondary of the transformers. No high-frequency currents have to pass through this channel, and if such a condenser is provided it will immediately permit parasitic oscillations to occur, and the receiver will burst into inaudible and uncontrollable oscillation which simply makes it dead and lifeless.

Further operating details, together with the settings for the various long-wave stations obtained with the Daventry coils, and a long list of suitable valves to use will be given in next month's issue. The instructions for building the receiver are, however, complete in this article, so that the intending constructor need have no hesitation in commencing the construction of the receiver.

## THE "MEWFLEX"

A RADIO PRESS STAR SET

Stable—Selective—Non-Radiating.

This Three-valve Reflex Set, developed by the Elstree Laboratories is described in the September Special Autumn Double Number of

'MODERN WIRELESS'

NOW ON SALE • Price 1/6

# MECHANICAL PERFECTION

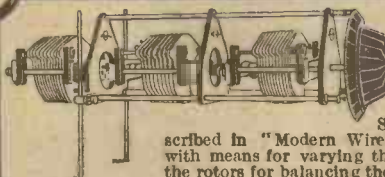

**GANG CONTROL CONDENSERS**  
 This Condenser was designed specially for use in the "Elstree Solodyne" receiver described in "Modern Wireless," and is provided with means for varying the relative positions of the rotors for balancing the coils and aerial.  
 Price, without dial .. .. £3 10s.

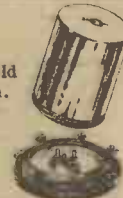

**COIL SCREENS**  
 These screening boxes screw into the base shield and provide a perfect electrostatic screen. Sockets and terminals are to Radio Press standards. Finished in highly polished aluminium and ebonite.  
 Price 15/-



**NEUTRALISING CONDENSERS**  
 These condensers have been specially designed to provide a high-class component for use in Radio Press circuits. The minimum capacity is '000002 uF. while the maximum capacity is '000025 uF. giving sufficient range to neutralise all makes of valve.  
 Price (Board or Panel mounting) 7/-



**JACKS**  
 Bowyer-Lowe Jacks mark a great advance in design, while the workmanship is typical of Bowyer-Lowe quality production.  
 Single circuit open .. 2/2  
 Single circuit closed .. 2/7  
 Double circuit .. 3/-  
 Filament single control 2/8  
 Filament double control 3/3



**SUPER HET. TRANSFORMER**  
 Thousands of amateurs have built Super Het. sets using Bowyer-Lowe transformers with perfect success. Set of four transformers, £4; Oscillator couplers, 300-600 m. and 550-2000 m. £1 each; Base for same, 4/-; Constructor's Kit, £10.



**ANTIPONG VALVE HOLDER**  
 The Bowyer-Lowe Antipong valve holder is the only valve holder with such a low capacity, combined with the cushioning necessary for preventing microphonic noises in your valves. Universal fitting. Baseboard or panel mounting. Price 3/- complete.

For further particulars of the above and of all our components, send 1½d. in stamps for the latest number of the Bowyer-Lowe Radio News. This also contains two constructional articles of interest to amateurs. A novel and complete portable set and a four-valve receiver are fully illustrated and described.  
 Visitors to Olympia may obtain a copy at our Stand No. 126, Sept. 4-18th, where we shall be pleased to meet all our old acquaintances and make many new ones.



ANNOUNCEMENT BY BOWYER-LOWE CO. LTD. LETCHWORTH. HERTS.

In replying to advertisers, please mention THE WIRELESS CONSTRUCTOR.

# Presented FREE

with  
the next issue

A WONDERFUL FREE GIFT BOOKLET, THE RAPID STATION GUIDE, will be presented with every copy of the October issue of MODERN WIRELESS. The wavelength redistribution of European stations will make this presentation Booklet so extremely useful that you should go to your newsagent to-day without fail and put this issue on order.

Unless you order you may not be able to buy your copy on the morning of the 1st of October.



The Editor, J. H. REYNER, B.Sc. (Hons.), A.C.G.I., D.I.C., A.M.I.E.E.

The Contents for the October issue will include:

**HOW TO BUILD AN EIGHT-VALVE SCREENED-COIL SUPERHETERODYNE**  
By G. P. KENDALL, B.Sc.

**MODERN DESIGN IN SIMPLE SETS**  
By J. H. REYNER, B.Sc. (Hons.), A.C.G.I., D.I.C., A.M.I.E.E.

**HOW TO BUILD AN H.T. CHARGING UNIT**  
By the Staff of the Elstree Laboratories.

**MORE ABOUT THE 'ELSTREE SOLODYNE' FURTHER HINTS ON THE "MEWFLEX" REPRODUCING THE LOW TONES**

By CAPT. H. J. ROUND, M.I.E.E.

## MODERN WIRELESS

ONE SHILLING MONTHLY.

Obtainable from all Newsagents, Booksellers or Bookstalls, or direct from the Publishers, Radio Press, Ltd., Bush House, Strand, London, W.C.2. Subscription Rates 15/- per annum (13/6 per annum Canada and Newfoundland). Lesser periods pro rata.



From the nearest Newsagent -



# Apparatus tested

For "The Wireless Constructor" at our Elstree Laboratories.

## "Ebonart"

MESSRS. REDFERNs have submitted to us some samples of their "Ebonart" panels for wireless apparatus. This material is similar in appearance to ordinary ebonite, and in fact appears to be a high grade form of this commodity.

On test it was found to be exceedingly good. It was easy to work without being in any way "cheesy." It did not soften too easily with heat, a point which should render it less liable to warp due to changes in temperature. It was also very strong from a mechanical point of view.

A sample of mahogany finished material proved less strong than the more homogeneous black sample, but otherwise it was in every way equal to the first.

This material is the best we have tested for some considerable time, and we can recommend it.

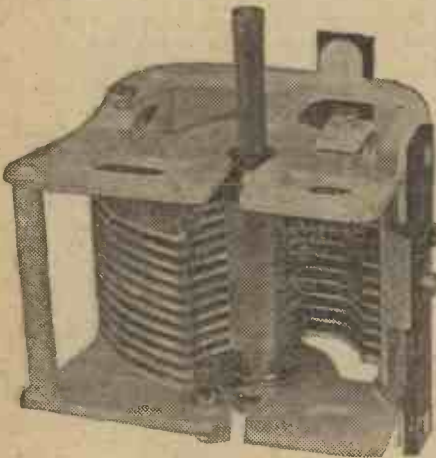

The Cleartron Di-Kast Condenser is of robust construction.

## Valves

WE have received a selection of valves from Messrs. Radio Valves, Ltd. Two of these were of the bright-emitter type with tubular bulbs, the valve legs being carried in an insulated base of brown material. At the rated filament potential of 3.5 volts, a current of .5 of an ampere was taken, while their impedance and amplification ratio taken at 80 volts plate potential were 55,000 ohms and 10 respectively.

When compared in a three-valve set with "R" valves of known performance, these valves were found to give satisfactory results as H.F. amplifiers, detectors, or L.F. amplifiers.

Two other valves also submitted were of the "R" type, but with spherical pipless bulb. The filament current at 4.2 volts was .7 amps., and, when measured at a plate voltage of 80, the impedance was found to be 30,000 ohms and an amplification ratio of 13.3.

Satisfactory results were obtained in a three-valve receiver using these valves as H.F. detector, or L.F. amplifier, these results being on a par with those obtained with an "R" valve of a known performance.

Two valves of the .06 type were also tested, and were found to take their rated current of .06 amp. at a potential of 3 volts. An impedance of 27,000 ohms, and an amplification factor of 10, were obtained at an anode potential of 80 volts, while their performance was up to standard.

These valves, further, appear to have a low capacity, since only a small value of the neutralising condenser was required to stabilise them when used in a neutralised stage of H.F.

## Cleartron Di-Kast Condenser

AN interesting component has been sent to us for test in the Cleartron Di-Kast Condenser. This is an attempt to produce on an economical scale a real precision condenser. The stator and rotor plates are each die-cast in one piece and subsequently assembled in a suitable skeleton framework. A spring connection is taken from the moving plates, and soldering tags are provided for the actual contact.

Two-hole fixing is provided for, a drilling template being supplied; but the instrument is somewhat difficult to fit and was not as rigid, when in position, as it should be. The rated capacity of the sample submitted was .0005, and on test this figure was found to be substantially correct.

The bearing which is provided is in the form of a spring washer of special construction, and while this gives a smooth and easy motion, it is possible, by exerting pressure upon the plates, to produce end play, with consequent variation of the capacity.

This criticism, however, is of minor

importance, and is only inspired by the fact that the remainder of the workmanship is of excellent quality. For ordinary use we have no hesitation in recommending this condenser.

## Cleartron Micro Station Selector

WITH the Cleartron Di-Kast Condenser we were supplied with a micro station selector. This is a slow-motion dial, the adjusting knob causing a rotation of the spindle through a reduction mechanism which moves the condenser spindle, and at the same time operates a pointer operating over a scale reading from 0 to 100.

The finish of the job is good, and the dial in operation was found to be free from backlash and smooth in action. The reduction mechanism is ingenious and simple. It consists of a wheel 3 in. in diameter provided with a rubber tyre, and engaging with this is a small roller to which

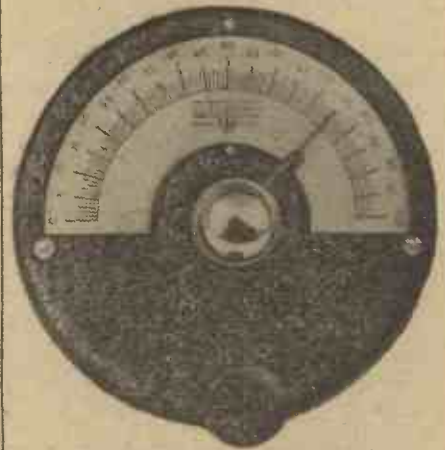

Fine readings are made possible with the Micro Station Selector, control being by means of the small knob at the bottom.

the actual operating knob is fixed. The whole is enclosed in a metal case so protecting it from damage, dust, dirt, etc., and we can recommend this component to our readers.

## S.P.D.T. Knife Switch

A NEAT and well-made single-pole double-throw knife switch has been sent to our laboratories for exam-

## Apparatus Tested—continued

ination and report by Messrs. A. F. Bulgin & Co., Ltd.

The switch presents a pleasing appearance when mounted, all visible metal parts being nickel plated. Contact is established by means of three spring sockets, the centre spring of which has the lever arm mounted on it, and the arm simply slips into the



The "Ealex" coil mount consists of a coil plug and hollow shell to contain a suitable winding.

other two sockets as required, the sockets, of course, being fitted one on each side of the centre spring. The box itself is utilised as a drilling template, while a further good point is that soldering tags are provided.

When in use a good electrical contact is made; it is simple to mount, and we have no hesitation in recommending it to our readers.

### Anti-Capacity Coil Mount

A NEW anti-capacity coil mount has been marketed by Messrs. J. J. Eastick & Sons, of Bunhill Row, E.C.

This accessory consists of a strip of fibre material folded to the shape of the usual type of plug-in coil. At the bottom of the strip a plug and socket are inserted, and kept in position by means of the fibre which is folded somewhat after the manner of a cardboard box lid.

Connections are made to the coil by means of screws or soldering tags, and when the coil is in position the fibre strip and cardboard side-pieces (which can be cut to suit the size of the coil constructed) keep the coil rigid.

### "All-Wave" Tuner

MESSRS. C. S. DUNHAM have submitted to us for test and report one of their "All-Wave" tuners.

This instrument consists of a composition tube  $3\frac{1}{2}$  in. in diameter and  $5\frac{1}{2}$  in. long, which carries two windings, one of thick and one of thin wire.

Tappings are provided so that the various amounts of inductance may be used, while a small rotor revolving



The "All-Wave" tuner, submitted by Messrs. C. S. Dunham, is designed for one-hole fixing.

within the tube carries a winding by means of which reaction may be applied. Terminals are provided for making connection to the reaction coil, the spindle of which carries a graduated dial and knob for controlling the amount of reaction.

When tested in the aerial circuit for tuning a three-valve set employing a .0005 variable condenser, the range of this instrument was found to be from 250 to about 2,800 metres, a satisfactory degree of overlap being obtained on each of the tappings.

## —supreme in practice

for Neutrodyne and Super-Het



In this advertisement we print a letter of remarkable interest:—

"I consider your Selector to be the only Variable Condenser which is suitable for the 'Split Coil Neutrodyne' Circuits. Both the rotor and stator are at High Frequency potential and with most Condensers this means that hand capacity effects are so troublesome as to make the circuit not worth while. I find, however, that your Selector—even in this circuit—is quite free of hand capacity."

A Dual Selector Condenser for the Elstree Six. Price £6 Set of Four (32/6 each).

Dual Condenser for the "Distaflex Two" .0005 mfd. each half - Price Type F, 26/-.

The Colvern Selector Low Loss. Reading to 1/1000th part of the variable capacity. Capacity .0005 mfd. £1 is. - .0003 mfd. £1 Type F. without gear attachment. Capacity .0005 mfd. 1½s. 0d. - .0003 mfd. 1½s. 0d. One hole fixing. Other capacities if required. Descriptive folder upon request. Colvern Independent Vernier - Price 2s. 6d. Ask your dealer also for the Colvern Low Loss Coil Former - Price 6s. 0d.

Collinson Precision Screw Co. Ltd.  
Walthamstow, London, E. 17.  
Provost Works, Macdonald Rd.  
Telephone—Walthamstow 532.

## a coil holder that does more

Use **TRIX** Switches, H.F. Transformers, Selenium Anode Resistances, etc.

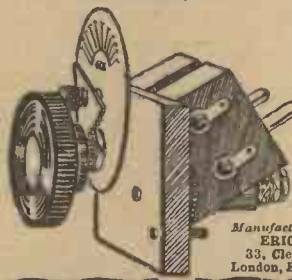

IT will do more than hold coils; it will give you perfect control of your coil adjustments and a visible indication in front of the panel of the exact movement.

The moving coil and the pointer are both geared 4 to 1, and move with velvet smoothness.

Back of panel, one-hole fixing, black or white 5/6  
ivory dial ... ..

(No. 272. Patent applied for.)

Manufactured by  
ERIC J. LEVER,  
33, Clerkenwell Green,  
London, E.C.1, & Branches.

# TRIX

## FORMO

### ULTRA LOW LOSS Straight Line Frequency Condenser.

Cone Bearings, Braced Vanes, Positive Collector. A Real Precision job.

Condenser only .0003µF.—.0005µF. 9/-  
Condenser with plain Dial 10/6  
Standard 1/2" Dia. Shaft.

SEND FOR CATALOGUE AND  
DESCRIPTIVE LITERATURE  
OF COMPLETE FORMO RANGE

THE FORMO COMPANY,  
Crown Works, Cricklewood, N.W.2.  
Phone: Hamp 1787.  
Manchester: Mr. J. B. Levee, 23, Hartley  
Street, Levenshulme.  
Phone: Heaton Moor 475,  
See page 1112 for Formo  
Transformer.





# Gifts for EVERY READER



IN becoming a regular reader of WIRELESS there are many pleasures in store for you.

With the issue on sale Tuesday, September 14th, you are presented free with a magnificent 20-page Sixpenny Booklet—The WIRELESS “Rapid Tuning and Operating Guide.” This is the only complete gift book of reference ever produced on this fascinating subject.

To be certain of obtaining the first of the series of valuable gifts to be given free with WIRELESS—the leading popular weekly—you are advised to place an order with your newsagent to-day. It will save you trouble if you ask him to deliver you your copy regularly every week.

In addition to the article by Mr. John Scott-Taggart the contents include:—

**Secrets of Modern Radio Efficiency.** The first of a series of articles. By J. H. REYNER, B.Sc. (Hons.), A.C.G.I., D.I.C., A.M.I.E.E.

**How We have Beaten America.** By PERCY W. HARRIS, M.I.R.E.

**Stereoscopic Broadcasting.** By CAPT. H. J. ROUND, M.I.E.E.

**Do you Dance by Radio?** By JACK HYLTON.

**How the New Wavelengths will Affect You.** By G. P. KENDALL, B.Sc.

**New Inventions at the Exhibition.**



Mr. John Scott-Taggart, F.Inst.P., A.M.I.E.E., Technical Director, in this issue describes THE ELSTREFLEX RECEIVER—the first two-valve reflex receiver to give selectivity and range—a wonderful set giving alternative programmes on the loudspeaker.



Obtainable from all Newsagents, Bookstalls and Booksellers, or direct from the Publishers, Radio Press, Ltd., Bush House, Strand, London, W.C.2. Subscription Rates, 13/- per annum throughout the world.

*From the nearest newsagent*



**USE DRY CELLS INSTEAD OF ACCUMULATORS**

**C**OLUMBIA Dry Batteries are much safer, cleaner and convenient to handle besides eliminating trouble and expense occasioned by the frequent recharging needed by the ordinary accumulator. You can eliminate the inconvenience of storage batteries entirely—there is a Columbia Dry Battery for every radio battery need.



Send for our useful and informative battery instruction books "How to get the most out of your radio batteries" and "Choosing and using the right radio batteries." They are sent post free on request.

**Columbia Dry Batteries**  
—they last longer

Ask your Dealer for full particulars concerning the complete range of Columbia Batteries or send direct to us.

**J. R. MORRIS,**  
15-19, KINGSWAY, LONDON, W.C.2.  
Telegrams: Colcarprod, London. Phone: Gerrard 3038

**A NEW RADIO PRESS ENVELOPE**

A new Radio Press Constructional Envelope is now on sale, describing "THE RAZOR-SHARP WAVEMETER,"

By J. H. REYNER, B.Sc. (Hons.), A.C.G.I., D.I.C., A.M.I.E.E.

With the large number of European broadcasting stations now in operation, a wavemeter is an indispensable adjunct to the wireless receiver. With the aid of a wavemeter, stations may readily be picked up and identified, the receiver may be calibrated, and numerous tests may be carried out.

"The Razor-Sharp Wavemeter" is just the instrument for you. It is a buzzer wavemeter, so that there are no valves or expensive batteries to be maintained. It is an instrument of great accuracy, many months of experiment and research having preceded its production. In addition, it is cheap and easy to construct, and the difficulties of calibration are non-existent, since calibration charts are included in the envelope.

ASK FOR RADIO PRESS ENVELOPE No. 14. PRICE 1s. 6d.

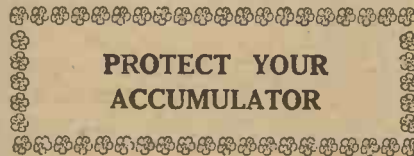

**PROTECT YOUR ACCUMULATOR**

**N**O matter how carefully it is handled, the low-tension accumulator is always liable to be short-circuited when experiments are being conducted or a receiving set is being tested out. The deleterious effects accruing from this can be completely overcome if some form of enclosed fuse is used to replace one of the ordinary

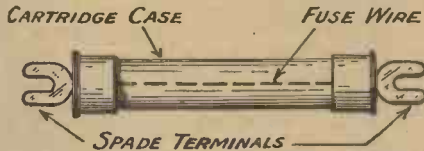

Fig. 1.—A fuse of the type shown is convenient to handle, and may save the accumulator from serious damage.

connecting links between the individual two-volt units of a four- or six-volt accumulator.

Reference to Fig. 1 will indicate the type of fuse suggested, ordinary spade terminals being provided to fit under the accumulator terminal wouids. The cost of such an accessory would be quite small, and the reason for employing an enclosed fuse is to avoid any possibility of danger from fire as a result of the fusing of the wire and the dropping of molten metal on to the celluloid case.

*There's proof positive in the N.P.L. Curve*



**THE WATMEL AUTO-CHOKE**

has won immense popularity among constructors because of its ability to amplify without coarsening TONE. The N.P.L. Curve of this ingenious component is "as straight as a die." N.P.L. Curve 103/6 and Booklet on request.



**The WATMEL WIRELESS COMPANY, LTD.**  
332a, Goswell Rd., London, E.C.1  
Telephone: Clerkenwell 7990.  
Lancashire and Cheshire Representative:  
MR. J. B. LEVEE,  
23, Hartley Street, Levenshulme, Manchester.  
TELEPHONE: 475 HEATON MOOR

**Double Your Income this Fascinating Way**

*My Wonderful Home-Money-Making Offer to YOU.*

**W**OULD you like to make as much money in your spare time every week of the year as you do in your usual occupation or business? If so, here is a delightful and most original way of doing it—easy, interesting, important, and with your profits absolutely guaranteed!

**FULL PARTICULARS FREE.**

Sit down NOW and send the coupon below which will bring you full details of how to turn your spare hours into cash by making a Patent-protected Electrical and Wireless Speciality by my revolutionary method. The efficiency, valve economy, cleanliness and wonderful qualities of this article—which you can make without possessing mechanical skill—ensure a wonderful demand by all wireless enthusiasts and wireless and electrical dealers, and your profits are BIG.

**MAKE YOUR KITCHEN TABLE INTO "A PAYING CONCERN."**

Very little space is needed—your kitchen table will suffice—the children can help. You require no machinery or "plant." You can work how and when you please. Your market cannot be "stolen," as only one person per 50,000 of the total population is granted a licence to manufacture under my Royal Letters Patent. Write TO-DAY for free particulars and get on the road to independence and prosperity.

**TURN YOUR SPARE HOURS INTO CASH**

"Make-Money-at-Home" Coupon  
To The England-Richards Co.,  
10d, K, King's Lynn, Norfolk.

Sirs: Please send me at once and FREE, details as to how I can Make Money At Home in my spare time. I enclose 2d. stamp for postage.

Name.....  
Address.....  
Wireless Constructor Oct. 1926.

**THE "NIGHT HAWK"**

(Continued from page 1052)

that of the S.L.W. The fact, however, that two small fixed condensers in series are used across the variables will slightly alter the curve, and you will not get a perfect straight-line reading of the frequencies plotted against degrees. This slight alteration, however, will not be found any practical disadvantage.

**Constructional Details**

It will be found that all of the components on the baseboard can be mounted and practically entirely wired up before the front panel is attached. I suggest to you as a convenience in construction that you mount the three condensers, switch and reaction condenser on the front panel, attach the brackets, and then stand the whole assembly in position against the baseboard, while you lay out your parts according to plan. When you have these all in place, you can secure them in position, remove the front panel assembly and get on with your wiring, only finally attaching the front panel when you have done practically all the work on the baseboard. This will be a great convenience, and will help you to obtain neat wiring with the minimum of trouble.

**Valves to Use**

In the Night Hawk I have rather concentrated on the use of the 2-volt valves which have recently been developed with such success. While I do not wish to convey the impression that the Night Hawk will not work just as well with 4- or 6-volt valves, I do wish to emphasise that it has been very thoroughly tried with the 2-volt, which seem to suit it excellently. In the two high-frequency stages and the detector I have used the Cossor .1 high-frequency valves very successfully, and in the two audio-frequency stages the Cossor Stentor Two with thoroughly satisfactory results. The remarkably high efficiency in current consumption of modern valves is indicated by the fact that with these five Cossor valves the total filament consumption is .6 of an ampere at 2 volts, or, expressed in another way, 1.2 watts. A year or two ago a single bright-emitter valve consumed between 2 and 3 watts; incidentally, the results obtained with these low-consumption valves are far better than those we used to get with the old bright-emitters.

I have also used with success the Mullard P.M.1 valves in the first three sockets, and the P.M.2 valves in the last two sockets; the current consumption of these valves is the same, i.e., .1 of an ampere at 2 volts for the radio-frequency and detector valves, and .15 of an ampere at 2 volts for the audio-frequency valves.

You will notice that I have fitted a  
(Concluded on page 1126.)

**EXPERTS IN RADIO ACOUSTICS SINCE 1908**

**IS THIS WHAT YOU'RE LOOKING FOR ?**

**T**ESTING the new 2-valve receiver at our Works at Slough, on a standard P.M.G. aerial, we tuned in the two Paris stations, London, Daventry, Bournemouth, Birmingham and Newcastle on the loudspeaker. This despite bad screening set up by a large power station not more than 50 yards from the vicinity of the laboratory. We were testing on 66 volts only. You can expect even better from the 3-valve Brandeset.



**THE BRANDESET II.**

The new Brandes 2-valve set features simplicity of control and ingenious compactness. Condenser dial, filament rheostat, reaction dial and "throw-over" switch for long or short wave tuning complete the panel controls. Straight line frequency condenser tuning and grid-bias

is employed. The standard coil is suitable for Daventry and no "plug-in" coils need be purchased. The L.T., H.T., and grid-bias leads are plated into one cable from rear of set.

**£6 10**

(Exclusive of Marconi Royalty and Accessories.)



**THE BRANDESET III.**

The new Brandes 3-valve receiver employs the same ingenious characteristics as the Brandeset II, except that an extra stage of Audio Frequency is employed. It has straight line frequency condenser tuning, grid-bias, and is adapted to long and

short wave tuning. Both receivers give most excellent loudspeaker reproduction on a number of stations, and are specially designed for this purpose.

**£8 10**

(Exclusive of Marconi Royalty and Accessories.)

**Brandes**

From any reputable Dealer.

**BRANDES LIMITED · 296 REGENT ST. · W.1**

61

Service Advertising

Stand 84, Olympia Radio Exhibition

The name 'LOTUS' is your guarantee of sound results and solid satisfaction

The 'LOTUS' JACK

Designed to take up the least space, the depth back of panel being 1 1/4 in. Made from best Bakelite mouldings, with nickel silver springs and pure silver contacts. One-hole fixing. Soldering contacts can be brought into any position.

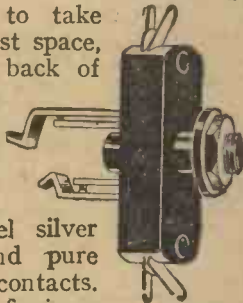

Prices No. 3, as illustrated 2/6 others from 2/- to 3/-

The 'LOTUS' JACK SWITCHES

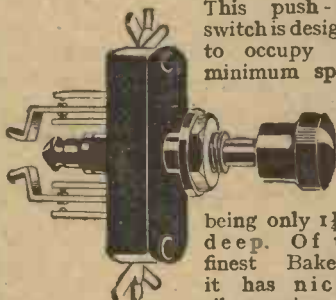

This push-pull switch is designed to occupy the minimum space,

Prices No. 9, as illustrated 4/- others from 2/9

being only 1 1/4 in. deep. Of the finest Bakelite, it has nickel silver springs and contacts of pure silver. Soldering contacts can be made to suit any wiring.

The 'LOTUS' JACK PLUG



Designed for use with Lotus Jacks. Made from best Bakelite mouldings and nickel plated brass parts. To fix, the wires are placed in slots and gripped in position by a turn of the screw cams.

Price 2/-

Made by the makers of the famed 'LOTUS' Vernier Coil Holders and 'LOTUS' Buoyancy Valve Holders  
Garnett, Whiteley & Co., Ltd.,  
LOTUS Works,  
Broadgreen Road, Liverpool.

THE "NIGHT HAWK"  
(Continued from page 1125)

35-ohm resistance for the first three valves and a 6-ohm resistance for the audio-frequency valves. The reason for this is that some readers may desire to try the set with the .06 ampere type of valve in the first three stages, and a 35-ohm resistance will enable even a 6-volt accumulator to be used with these valves. If it is intended to concentrate on 2-volt valves of the type described, however, it is only necessary to provide two 6-ohm resistances. In any case, once you have got good results with this set, reduce the filament current as far as you can without detracting from the results. Both makes of valves will work well below 2 volts without loss of efficiency, and by reducing the current you will prolong the life of the valves.

For those who like the 6-volt valves or have a supply of them which they want to use, I may say that the 1/2-ampere 5.5- to 6-volt valves of the "small power type" work excellently in this set, and for the first three sockets I would recommend (for those who desire to use this type of valve) the high-impedance type designed for resistance-capacity amplification.

High Selectivity

At Wimbledon, Cardiff and Manchester can be completely separated from the London transmissions, being tuned in entirely on the loud-speaker. When you realise that on the same aerial at Wimbledon with a good modern crystal detector it is possible to obtain sufficient strength on a loud-speaker to make the news items audible on the other side of a quiet room when one listens carefully, you will realise that to get rid of the London signals and to receive Cardiff and Manchester without interference means selectivity of a very high order.

NOTE.—Complete details are given on these pages to enable you to build the "Night Hawk," and constructors need not hesitate to begin the construction of this set immediately. Blue prints of the diagrams may be obtained on application, with the coupon to be found elsewhere in this issue.

Further notes on neutralising and operation will be given next month.

THE NEW BROADCASTING WAVELENGTHS

The proposed new wavelengths are given in the table below, and it should be noted that they are at present only provisional. They are due to come into operation, however, on or about September 15th.

Geneva Plan Wave-length.	Name of Station.	Country.	Present Wave-length
588.2	Vienna II	Austria	530
	Linköping	Sweden	467
	Grenoble	France	475
577	PTT		
	Madrid II	Spain	392
	Jönköping	Sweden	265
566	Berlin II	Germany	562
	Orebroe	Sweden	237

**DECKOREM** BRITISH MADE RADIO PRODUCTS  
REGD. TRADE MARK.

**AN OUTSTANDING SUCCESS!**

BALANCING or Neutralising Condenser, for Baseboard Mounting. Can be locked in position when adjusted.

Recommended by many technical journals, and used with success in the "Magic Five" and other circuits.

PRICE 3/- EACH.  
New Large Pattern, For neutralising power valves of DE5 and DE5b pattern, PRICE 4/6 EACH. Regd. No. 715459

OBTAINABLE FROM ALL DEALERS.

**A.F. BULGIN & CO.**  
9-11, CURSITOR STREET  
TEL. HOLBORN 2072 CHANCERY LANE E.C.6, WORKS CHISWICK  
TRADE DECKO MARK

**RADIAX at OLYMPIA**  
See all our goods on Stand 32.  
THE "HERALD" L.F. TRANSFORMER

A screened model of our well-known open type "Herald." With earth terminal and nickel finish. Ideal for modern circuits and compact arrangement. Highly efficient in use and economical in price. We guarantee power and purity equal to any more expensive transformer and will refund cash if not entirely satisfied and goods returned within 10 days.

Ratios 3-1 and 5-1. Price 12/6.

**RADIAX LOW LOSS H.F. TRANSFORMERS.**  
On the lines of our well-known Low Loss plug-in coils, these Transformers are suitable for a variety of modern highly selective circuits. They have 4 pin plugs and 1 terminal for neutralising condenser, enabling easy change of wave length range.

No. 859, 300/500 metres... 8/6  
No. 860, 1,100/2,600 metres... 10/6  
No. 861, Socket base for same, 2/-

**RADIAX DX COILS increase selectivity 100 per cent.**  
Give an auto-coupled tuning circuit without altering your set. You will cut out the local, or separate two difficult stations to an extent undreamed of. Five terminals make it a Universal coil. Free chart given with each purchase, showing the many circuits in which this coil can be used—Auto-coupled, Neutrodyne, etc.

No. 35—4/8 No. 50—5/- No. 75—5/6  
No. 100—7/8 Set of 4—21/-  
Post. extra.

**RADIAX H.T. ACCUMULATORS**  
Give a perfect H.T. Supply for many months with one charge. Improve reception wonderfully.

10 VOLT UNIT ... 6/-  
60 VOLT BATTERY, 45/-

**RADIAX LTD.**  
44, Accessory House, Palmer Place, Holloway, London, N.7  
Part's Ad.

**A HOME FOR YOUR WIRELESS SET**  
OUR STANDARD CABINETS

are DUST PROOF and house the whole apparatus, leaving no parts to be interfered with. All you do is UNLOCK and TUNE IN. Made on mass production lines, hence the low price. Provision is made to take panels from 16x7 up to 30x18 in.

From £3 11 6 Write to-day for descriptive pamphlet and suggestions for adapting your receiver or panel in our Standard Cabinets. Immediate Delivery.

Carriage paid and packed free England and Wales.  
Money returned if not satisfied.

**MAKERIMPORT Co.** Dept. 20, Melville Chambers, 60a, Lord St., LIVERPOOL.

**YOU** can solder Easily, Safely, Quickly by using **BRITINOL** non-acid Self-Fluxing Wire Solder. Coils 6d. and 1/-, of good dealers, or post free direct from

The Originators of Easy Soldering

**BI-METALS, LTD.**

(Dept. II)  
SUGAR HOUSE LANE  
LONDON, E.15

It's Easy and Safe!

Geneva Plan Wave-length.	Name of Station.	Country.	Present Wave-length
566	Bloemendaal	Holland	—
555.6	Budapest	Hungary	546
545.6	Sundsvall	Sweden	545
535.7	Munich	Germany	485
526.8	Riga	Latvia	480
517.2	Vienna	Austria	590
508.5	Antwerp	Belgium	—
500	Zürich	Switzerland	515
	Helsingfors II	Finland	522
	Karlstad	Sweden	—
491.8	Aberdeen	Great Britain	496
	Birmingham	Great Britain	477.5
483.9	Berlin	Germany	505
476.2	Lyons PTT	France	480
468.8	Elberfeld	Germany	259
	Bergen	Norway	350
454.5	Boden	Sweden	1,200
477.8	Paris PTT	France	458
441.2	Brno (Brünn)	Czecho-Slovakia	527 (?)
434.8	Bilbao	Spain	415
428.6	Hamburg	Germany	392.5
422.6	Rome	Italy	425
416.7	Stockholm	Sweden	427
411	Erne	Switzerland	436
405.4	Glasgow	Great Britain	422
400	Mont de Marsan	France	390
	Cadiz	Spain	355
	Falun	Sweden	370
	Warsaw	Poland	—
	Koszice	Czecho-Slovakia	—
	Bremen	Germany	?
394.7	Frankfurt	Germany	470
389.6	Toulouse Radio	France	430
384.6	Manchester	Great Britain	378
379.7	Stuttgart	Germany	440
375	Madrid	Spain	373
370.4	Oslo	Norway	382
365.8	Graz	Austria	397
361.4	London	Great Britain	363.5
357.1	Breslau	Germany	416
353	Cardiff	Great Britain	353
348.9	Prague	Czecho-Slovakia	365.5
344.8	Seville	Spain	357
340.9	Paris Petit	France	358
	Parisien	—	—
337	Copenhagen	Denmark	340
333.3	Naples	Italy	350
	Reykjavik	Iceland	—
329.7	Nürnberg	Germany	340
328.1	Belfast	Great Britain	440
322.6	Leipzig	Germany	452
	Dublin	Ireland	390
315.8	Milan	Italy	320
312.5	Newcastle	Great Britain	404
309.3	Marseilles PTT	France	351
306.1	Bournemouth	Great Britain	386
303	Münster	Germany	410
300	Bratislava	Czecho-Slovakia	300
297	Agen	France	318
	Leeds	Great Britain	343.5
	Hanover	Germany	297
	Carthageña	Spain	330
	Jyväskylä	Finland	301.5
294.1	Dresden	Germany	294
	Trollhattan	Sweden	345
	Bilbao	Spain	418
	Valencia	Spain	400
	Liège	Belgium	280
291.3	Lyons (Radio)	France	280
288.5	All British Relays, except Leeds and Bradford	—	—
283	Dortmund	Germany	387
280.4	Barcelona	Spain	324
277.8	Caen	France	332
	Barcelona II	Spain	462
	Seville II	Spain	300
275.2	Angers	France	275
	Madrid III	Spain	340
	Eskilstuna	Sweden	243
272.7	Zagreb	Jugo-Slavia	—
	Cassel	Germany	273
	San Sebastian	Spain	343
	Norrköping	Sweden	260
260.9	Gothenburg	Sweden	290
254.2	Bradford	Great Britain	308
	Kiel	Germany	233
	Malaga	Spain	—
252.1	Montpellier	France	238
	Stettin	Germany	241
	Umea	Sweden	—
250	Gleiwitz	Germany	251
245.9	Toulouse PTT	France	260
241.9	Königsberg	Germany	462
240	Helsingfors (I)	Finland	318
238.1	Bordeaux	France	—
229	Malmö	Sweden	270
219	Kovno (3)	Lithuania	—
217.4	Luxemburg	Luxemburg	—
211.9	Kiev	Russia	281
204.1	Gäffe	Sweden	208.9
202.7	Salamanca	Spain	—
	Christianhamn	Sweden	202
	Asturias	Spain	—
201.3	Oviedo	Spain	—

# REPAIRS

By specialists skilled in every form of accurate and intricate coil winding.

Headphones, Loud Speakers and Transformers rewound, remagnetised, and reconditioned **EQUAL TO NEW** and returned the same day on C.O.D. system. The unsolicited opinion of one of our many satisfied clients "—all I can say is, they are better than when new."

VARLEY Magnet Co.  
Coil Dept.:  
Woodwich,  
S.E.18.

**VARLEY**

Proprietors:  
Oliver Pell  
Control Ltd.

## PICKETT'S CABINETS

for every Wireless Constructor.

"Dawlow" Model from 30/-  
"Elstree Solodyne" } from 25/- each.  
"Elstree Rev. Reflex" }  
"The Night Hawk" }

Send for Cabinet Designs FREE.

PICKETT'S CABINET (W.Cr.) WORKS,  
Bexley Heath (Nr. London).

## Valves Repaired

AS GOOD AS NEW!!

HALF LIST PRICE

Except Weco, S.P.'s, and low capacity (type). Minimum D.E. Current 0-15 amps when repaired.

ALL BRIGHT & DULL EMITTERS

Listed at less than 10/-.

MINIMUM CHARGE - - 5/-

VALCO LTD., Dept. C., Tabor Grove, Wimbledon, S.W.

## Build Your Own LOUDSPEAKER

WITH A LISSENOLA OR BROWN A, and our COMPONENTS. You can construct yourself a handsome CONE type, or FLEATED PAPER type LOUDSPEAKER in half an hour for less than it would cost you for the ordinary cheap horn type Loudspeaker. You will obtain VOLUME, CLARITY, and unsurpassed tonal quality. Prices, particulars and Diagrams for Stamp. TRADE inquiries invited. Tell your dealer. GOODMAN'S, 27, FARRINGDON ST., E.C.4. Also obtainable from Specialist Stores, 4-6, Mason's Gate, E.C.3

## STERLING RECEIVERS

SENSATIONAL OFFER!

Having purchased a large number of Sterling 2 Valve Loud Speaker Sets, we are offering them to the public on unprecedented terms. A genuine Sterling 2 Valve Loud Speaker Set complete, ready for immediate use with D.E. '06 Valves, H.T. and L.T. accumulator, Ariel Equipment and one of our World Famed De Luxe Excellence Loud Speakers. Price £13 15s. 0d., royalties paid. Terms 15/- Deposit and 15 Monthly Payments of 20/-.

Send for one of these Superb sets at once as the number for sale is limited, and when sold cannot be repeated under double the price.

Free Catalogue on Application

The Wireless Distributing Co., Ltd., (Dept. A.C.),  
Wireless House, Stoke Newington, N.16



## CABINETS

IN THIS ISSUE:

TWO VALVE REFLEX.

Oak, £1 10 0 Mahogany, £1 14 6

THE NIGHT HAWK.

Oak, £1 8 6 Mahogany, £1 13 0

CARRIAGE AND BASEBOARDS INCLUDED.

Enquiries for all Cabinets to

H. CATTERMOLE

(New Premises) 227, ANLABY ROAD, HULL.

LITTLE WIRELESS GADGETS

Small Parts to the Trade

MAP Co., 246, Gt. Lister St., Birmingham.

# TRIUMPH

## CUSHION ANTI-MICROPHONIC VALVE-HOLDER

HEIGHT OF PERFECTION IN VALVE SEATING.

PAT. APPD. FOR Ref. No. V190

Price 2/6

SEE STAND No. 238 NATIONAL RADIO EXHIBITION.

Ask your Dealer for full list of the TRIUMPH GUARANTEED COMPONENTS & SETS or send P.C. mentioning Wireless Constructor to: A. H. CLACKSON, LTD., WHITE HART WORKS, LONDON, N.22

AGENTS to sell cheapest and safest non-pumping petrolgas lamp; good income earned converting paraffin lamps into 150 c.p. Titus Light. TITUS, Kingston, BRIGHTON.

TRADE MARK

FINEST QUALITY RADIO COMPONENTS. EVERY COMPONENT IS PERFECT.

REGISTERED

R.D. 40. Perm. Detector 2/- each.

Of all High-Class Radio Dealers or Sole Makers, JEWEL PEN Co. Ltd. Radio Dept. 41, 21/22 Gt. Sutton St., E.C.1

## SOLDERING SUPERSEDED "KRISCROS" CONNECTORS

EASILY APPLIED: EFFECTIVE: HEAT: ENSURE BETTER RESULTS

PERFECT JOINTS "A KRISCROS" FOR EVERY CONTACT

Prices from 1/- per doz. Send for List.

KRISCROS COMPANY, 50, GRAY'S INN ROAD, LONDON, W.C.1

INDEX TO ADVERTISERS.

Artrcraft Company (The) ...	1128
Ashley Wireless Telephone Co., Ltd. ...	1102
Autoveyors, Ltd. ...	1106
Batteries, Ltd. ...	1070
Beard & Fitch ...	1084
Bedford Electrical & Radio Co., Ltd. ...	1112
Belling & Lee, Ltd. ...	1075
Benjamin Electric Co. ...	1092, 1093
Bi-Metals, Ltd. ...	1127
Bird (Sydney S.) ...	1091
Black (Alexander) ...	1123
Bowyer-Lowe Co., Ltd. ...	1119
Brandes, Ltd. ...	1104, 1118, 1125
Bulgin (A. F.) & Co. ...	1126
Burne-Jones & Co., Ltd. ...	1045
Bush House ...	1128
Carrington Mfg. Co., Ltd. ...	1112
Cattermole (H.) ...	1127
Caxton Wood Turnery Co. ...	1117
Clackson (A. H.) ...	1127
Cleartron Radio, Ltd. ...	1065
Collinson Precision Screw Co. ...	1122
Cossor (A. C.), Ltd. ...	1055
Coventry Direct Supplies, Ltd. ...	1128
Curtis (Peter), Ltd. ...	1098
Dubilier Condenser Co. (1925), Ltd. ...	1075
Economic Electric, Ltd. ...	1091
Electron Co., Ltd. ...	1105

England-Richards-Co. ...	1124
Eton Glass Battery Co. ...	1128
Falk, Stadelmann & Co., Ltd. ...	1091
Ferranti, Ltd. ...	1075
Finston Mfg. Co., Ltd. ...	1115
Forno Co. ...	1112, 1122
Gambrell Bros., Ltd. ...	1112
Garnett, Whiteley & Co., Ltd. ...	1068, 1116, 1126
General Radio Co., Ltd. ...	1123
Goodman's ...	1127
Graham (Alfred) & Co. ...	1076
Hart Accumulator Co., Ltd. ...	1067
Hunt (A. H.), Ltd. ...	1068
Holzman (Louis) ...	1112
Igranic Electric Co., Ltd. ...	1071
International Correspondence Schools, Ltd. ...	1105
Jackson Bros. ...	1116
Jewel Pen Co. ...	1127
Kriseros Co. ...	1127
Lever (Eric J.) ...	1122
Lissen, Ltd. ...	1087
London Electric Wire Co. & Smiths Ltd. ...	1079
London & Provincial Radio Co., Ltd. ...	1111
London Radio-Supply Co. Ltd. ...	1128
Lustrolux, Ltd. ...	1090
McMichael (L.), Ltd. ...	1030
Makerimport Co. ...	1126
M.A.P. Co. ...	1127
Morris (J. R.) ...	1124

Mullard Wireless Serv. Co., Ltd. Cover ii	
N.M.O. Detectors, Ltd. ...	1115
Oldham & Son, Ltd. ...	1072
Ormond Engineering Co., Ltd. ...	1089
Paragon Rubber Mfg. Co., Ltd. ...	1112
Penton Engineering Co. ...	1070
Peto-Scott Co., Ltd. ...	1096, 1117
Pettigrew & Merriman (1925), Ltd. ...	1111
Picketts Cabinet Works ...	1127
Portable Utilities Co., Ltd. ...	1099
Pye (W. G.) & Co. ...	1103
Radiax, Ltd. ...	1126
Radio Instruments, Ltd. Cover iv	
Raymond (K.) ...	1103
Rectalloy, Ltd. ...	1111
Rooke Brothers, Ltd. ...	1090
Rotax (Motor Accessories), Ltd. ...	1101
Sancto (H.) ...	1123
Sferavox ...	1115
Standard Insulators ...	1117
Telegraph Condenser Co., Ltd. ...	1100
Telsen Electric Co. ...	1070
Titus ...	1127
Valco, Ltd. ...	1127
Varley Magnet Co. ...	1109, 1127
Watmel Wireless Co., Ltd. ...	1124
Wilkins & Wright, Ltd. ...	1106
Wireless Distributing Co. ...	1127
Wolf (M. & A.) ...	1117
Wright & Weaire ...	1105

**FREE OFFER.** Final closing date. Orders to build sets designed by the Radio Press received up to September 25th will be executed at the cost of the components only, without any charge whatsoever for construction. First-class workmanship.

**LONDON RADIO SUPPLY CO.,**  
11, OAT LANE, LONDON, E.C.2.  
Phone: City 1977.

For clearer and more selective results use the  
**CLAREBEX AERIAL**  
Non-directional, easy to fix and ideal for neatness and limited space.  
Price 17/6 Particulars sent on request.  
H. SANCTO (Dept. W), TICEHURST, SUSSEX.

**WET H.T. BATTERIES**

British made (round or square) Leclanche Glass Jars, 2 1/2 x 1 1/2 x 1 1/2, for wet H.T. Units. Waxed, 1/3 doz., plain, 1/- doz. Zincs, 1/- doz. Grade 1 Sacs, 1/6 doz. Grade 2 Sacs, 1/3 doz. Carriage and packing extra. Eton Glass Battery Co., 46, St. Mary's Rd., Leyton, E.10

**2-VALVE AMPLIFIER, 35/-**

1-Valve Amplifier 20/-, as new. Valves, D.E. '06 7/-, Headphones 8/6 pair. New 4-Volt Accumulator 13/-, New 50-Volt H.T., guaranteed, 7/-, 2-Valve All 8tn. Set, £4. Approval willingly. Write for free bargain list.  
C. Taylor, 57, Studley Road, Stockwell, London.

**A WIRELESS DOCTOR**

If your set is giving trouble or you want advice, a competent expert will call and put you right (London and Home Counties). No result, no charge. Sets installed and maintained.  
**ALEXANDER BLACK, 2a, Woodville Grove, N.16.**  
Clissold, 3657.

**WIRELESS**

Capable, trustworthy men with spare time who wish to substantially increase income required where we are not fully represented. Applicants must have practical knowledge of installation of Set and Aerial, be a Householder or live with parents, and be able to give references; state age and experience. Address Dept. 22, **GENERAL RADIO COMPANY LIMITED,** Radio House, Regent Street, LONDON, W.1.

**ACCUMULATORS ON EASY PAYMENTS**

60 Volt High Tension Accumulator complete, in varnished case, built up in 20 volt sections. Tapping arranged every 10 volts. 45/- CASH, or 12/6 DOWN and 6 monthly payments of 6/- Carriage paid. Satisfaction or money back. Write for Lists to Dept. 13, Coventry Direct Supplies, Ltd., Coventry  
Any wireless goods easy payments

**ARTCRAFT**  
Cabinets "Popular Type"  
Oak or Mahogany Cabinets of Artcraft design and construction are a credit to the set you build

Sizes of "Artcraft Popular Type" Cabinets

Panel Size	Depth	Price in Oak	Price in Mahog.
9 x 6	6 x 6	6/0	10/0
10 x 8	6 x 6	8/0	12/0
12 x 10	8 x 8	12/0	16/0
14 x 10	8 x 8	14/0	19/0
16 x 8	8 x 8	14/0	19/0
18 x 12	8 x 9	21/0	29/0

Baseboards Free. Hinged Lids 1/6 extra.  
Prices include packing, carriage and insurance to any station in England and Wales. Prompt delivery guaranteed.

Send for Illustrated Brochure

The **ARTCRAFT Co.**  
156, CHERRY ORCHARD RD., CROYDON  
Parr's Ad.

**BUSH HOUSE**  
The Largest Wireless House outside London.  
CALL IN AND SEE US.  
**PARTS FOR ELSTREE SIX**  
and all other POPULAR CIRCUITS.  
Do not fail to write for it—it is sure to be in Stock  
Send for List Now.  
60 Volt Sure Life Batteries - 7/6 Guaranteed  
100 " " " " - 12/6 and post free  
9 Volt Grid Bias " " - 1/- over 5/-  
All makes of Valves in Stock.  
**35, Shudehill, Manchester**

**COUPON** QUESTIONS AND ANSWERS.  
This Coupon must be accompanied with a 2/6 P.O. and Stamped Addressed Envelope.  
**"Wireless Constructor,"** OCTOBER, 1926.

**FREE BLUEPRINT SERVICE**  
**COUPON**  
Wireless Constructor, Vol. II, No. 12, Oct., 1926.  
This coupon entitles the reader to one back-of-panel blueprint of any set described in the above issue, and must accompany each postal application.



## Exhibition Time is Spending Time

THE WIRELESS DEALER with the September issue enters into the third volume and the second year of publication. In surveying its truly remarkable progress in the forefront of trade journalism we know that, throughout the world, our subscribers will be anxious to continue the regular receipt of their copies month by month.

**SUBSCRIPTION RATES:**  
 7/6 per annum (abroad 10/-). Available to the Trade only. Trade card or business heading should accompany every subscription to the SALES MANAGER, Radio Press, Ltd., Bush House, Strand, London, W.C.2

So that you may continue to receive your copies for the coming year regularly on the day of publication write to the Sales Manager to-day. The fact that the current issue is the first of a new volume, renders to-day a suitable time to enter a subscription. A post-card will bring you a specimen copy by return.

*The Contents of the September issue include:*  
 Full Exhibition News; New Components for 1926-1927; Exhibitions in the Provinces; Radio in New York; List of Exhibitors; Complete Plan of Exhibition; What to look for at the Exhibition; Trade Personalities; New Apparatus tested at Elstree.

**VISIT THE DEALER STAND—No. 57**

*The* **Wireless Dealer**  
 AND MANUFACTURER



## Two R.I. Components to Simplify Set Construction

Is your set going to give satisfactory results "first time out"? That is always the question for the home constructor. You cannot answer with absolute certainty, of course, but by careful choice of components you can always make fairly sure of a successful job.

Here are two R.I. units that will do much to eliminate the risk of failure.

**THE R.I. MULTI-RATIO TRANSFORMER** with its seven ratios and three impedance values will operate perfectly in any circuit and with any valve you may use.

It is only a question of experimenting with your connections to the terminals until you find the combination that gives the finest results.

The patented system of winding ensures freedom from breakdown, and the metal shroud prevents all distortion.

From letters received we see that thousands of constructors and experimenters have already appreciated the great adaptability of this instrument, and all of them attribute to its use the wonderful purity of reception they now obtain.

Price - - 27/6

### THE R.I. RETROACTIVE TUNER

a tuning unit built to supersede the ordinary plug-in coils with coil holder. It covers the wavelengths from 175—4000 metres and gives efficient aerial reaction over the entire range. This is most important when you consider the difficulty of selecting the correct combination of plug-in coils over such a wide range of wavelengths. The unit costs less than a set of plug-in coils with coil holder to cover the same range, and it will certainly solve all tuning troubles you might experience using any other method.

Price - - 39/6

Write for the new R.I. Catalogue.

OLYMPIA, SEPTEMBER 4th—18th. STANDS 145 & 147



# THE MARK OF BETTER RADIO

Advt. R.I. Ltd., 12, Hyde Street, New Oxford Street, London, W.C.1.

Published by RADIO PRESS, LIMITED, Bush House, Strand, London, W.C.2, on the 15th of each month, and Printed for them by THE AVENUE PRESS (L. Upcott Gill & Son, Ltd.), 55-57, Drury Lane, London, W.C.2. Address for Subscriptions and Editorial Communications:—Bush House, Strand, W.C.2. Address for Advertisements:—Advertisement Manager, THE WIRELESS CONSTRUCTOR, Bush House, Strand, W.C.2. Phone: City 9911. Registered as a magazine for transmission by Canadian Magazine Post. Subscription rates U.K. and abroad:—8s. 6d. per annum, 4s. 3d. for six months; Canada, 7s. 6d. per annum, 3s. 9d. for six months. Sole Agents for Australasia:—GORDON & GORCH (Australasia), LTD. For South Africa:—CENTRAL NEWS AGENCY, LTD. American Agents:—INTERNATIONAL NEWS CO., New York. Canadian Agents:—THE AMERICAN NEWS CO., LTD. also IMPERIAL NEWS CO., LTD.